

Additive Manufacturing – next generation AMnx

Study

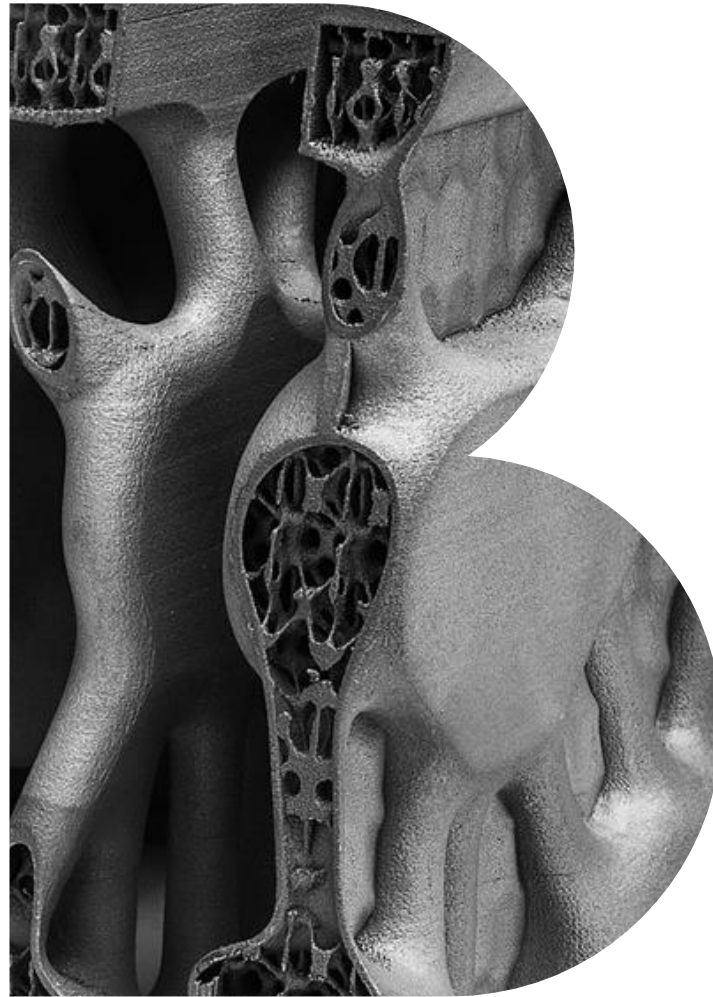

Contents	Page
Introduction	3
A. Engineering & software	10
B. Materials	26
C. Machines	35
D. Post processing	56
E. Services	62
F. Cost model	66
G. Market development	74
H. Stock market	78

This study has been prepared for general guidance only. The reader should not act on any information provided in this study without receiving specific professional advice. Roland Berger GmbH shall not be liable for any damages resulting from the use of information contained in the study.

Introduction



AM has become a mature series production technology – Significant innovations and continuing growth still expected

Additive Manufacturing – next generation | A Roland Berger study (1/2)



For six years we have been observing the development of metal Additive Manufacturing (AM), primarily in the aerospace and turbine industries, and realized the groundbreaking potential of this new production technology. The 2013 study aimed to inform our Engineered Products clients about available technologies, manufacturing cost models and trends, as well as the landscape of machine suppliers and service providers. The study was very well received by our technical clients and led to a series of AM industrialization and strategy projects for our company.

After a lengthy development period, AM has now matured and we can see that the industry is preparing to install large printing capacities for industries like aerospace in northern Germany. Series production with four lasers capable of simultaneously building one part can now build chambers up to 800 mm, and modular machine concepts ready for further automation are already standard today.



As the industry has achieved manufacturing readiness we want to look into the 5 to 15 year future of AM, which is why we named this study "Additive Manufacturing – next generation (AMnx)". We are focusing on upcoming innovations in the field of engineering & software, machine technologies and configurations, materials, post processing, service and the different impacts on cost, market growth and stock valuations.

AM has become a mature series production technology – Significant innovations and continuing growth still expected

Additive Manufacturing – next generation | A Roland Berger study (2/2)



Throughout our projects we have identified that advanced product designs will be a key factor for success in AM production. This study therefore analyzes the complete software process chain and supplier landscape. Owing to the fast availability of prototypes, the lower manufacturing complexity and advancing digital technologies, we expect mechanical engineering to become more similar to software design. In the long run this will impact the way engineering organizations work.

We can already see that the previous machine supplier landscape, dominated by German suppliers, has been disrupted by new players and new machine concepts. After the 3D printing hype hit its peak at the end of 2013, the stock market has calmed down and we are seeing a more realistic valuation of 3D companies. We are confident that the 3D market will continue to grow significantly and that the speed of innovation will not slow down.



This new study is intended to provide an overview of new AM technologies and market trends, and to raise your awareness of the upcoming innovations that could change your current business model.

We hope you enjoy reading this study – please do not hesitate to contact us if you have any questions. We'll be happy to support you further in the digitization of your engineering and development processes and in developing your 3D printing strategy.

Roland Berger is a trusted advisor for Additive Manufacturing (AM) in the Engineered Products & High Tech industry

AMnx @

Roland Berger



Engineered Products & High Tech Competence Center



- > Founded in 1969 as a one-man business, we now have successful operations in all major international markets
- > Largest consulting firm with European/German roots
- > Among the top 3 players for strategy consulting in Europe, number 1 for mechanical & plant engineering
- > Team of 2,400 employees worldwide, of whom 180 are partners



Aerospace & defense



Energy equipment



Long lifecycle products



Digital technologies

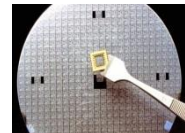

B2B electronics



- > Additive Manufacturing is part of our digitization initiative
- > The last Roland Berger study about Additive Manufacturing was published in 2013
- > Relevant project experience ever since forms the basis for the updated study at hand
- > Our consulting services for AM range from business development to operational excellence

Additive Manufacturing (AM) has seen strong development in the recent past – What's next (AMnx)?

Emergence of Additive Manufacturing

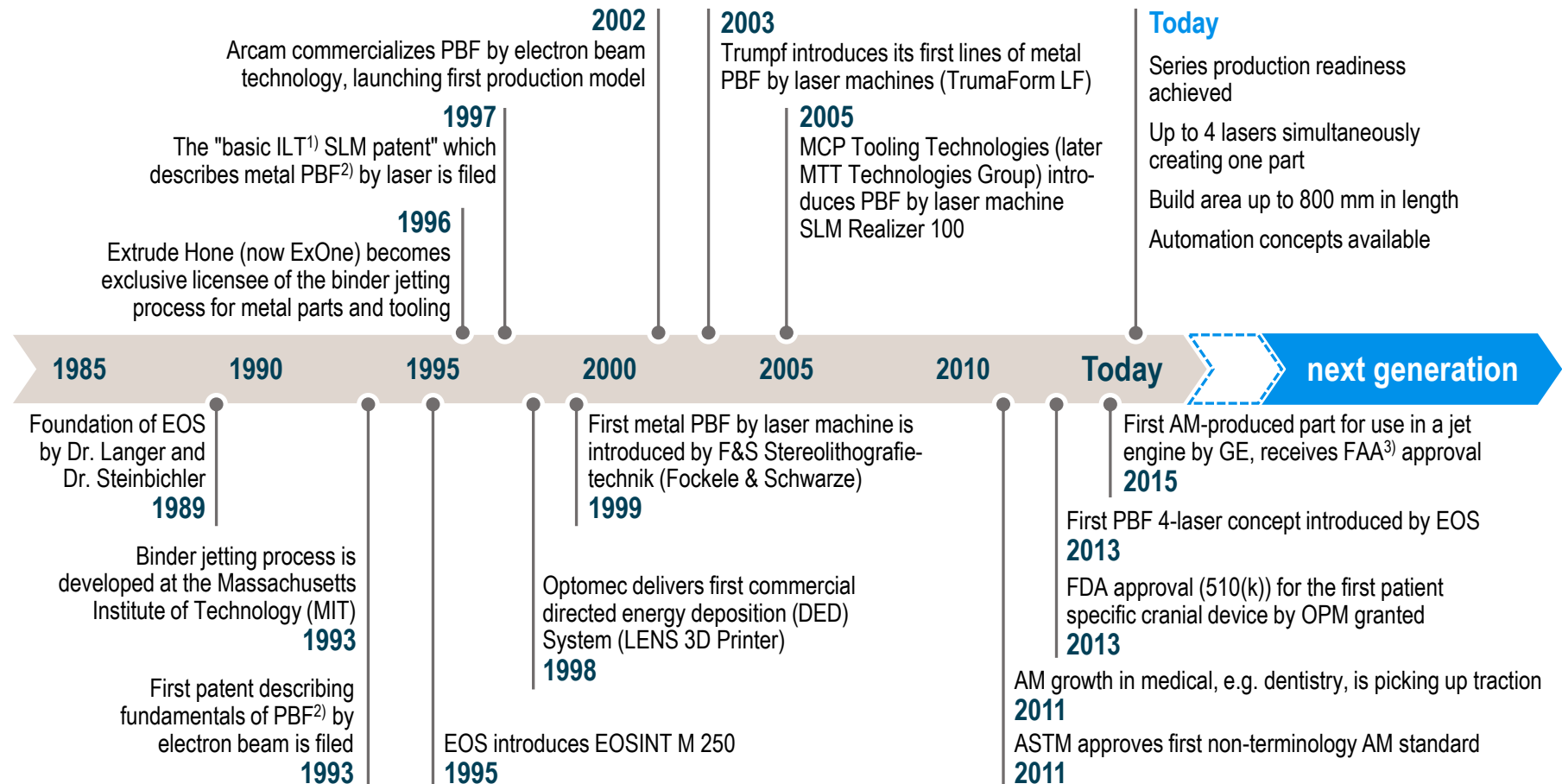

1) Fraunhofer Institute for Laser Technology 2) Powder bed fusion 3) Federal Aviation Administration

Additive Manufacturing – next generation (AMnx) is characterized by innovations along the entire AM process chain

Executive summary

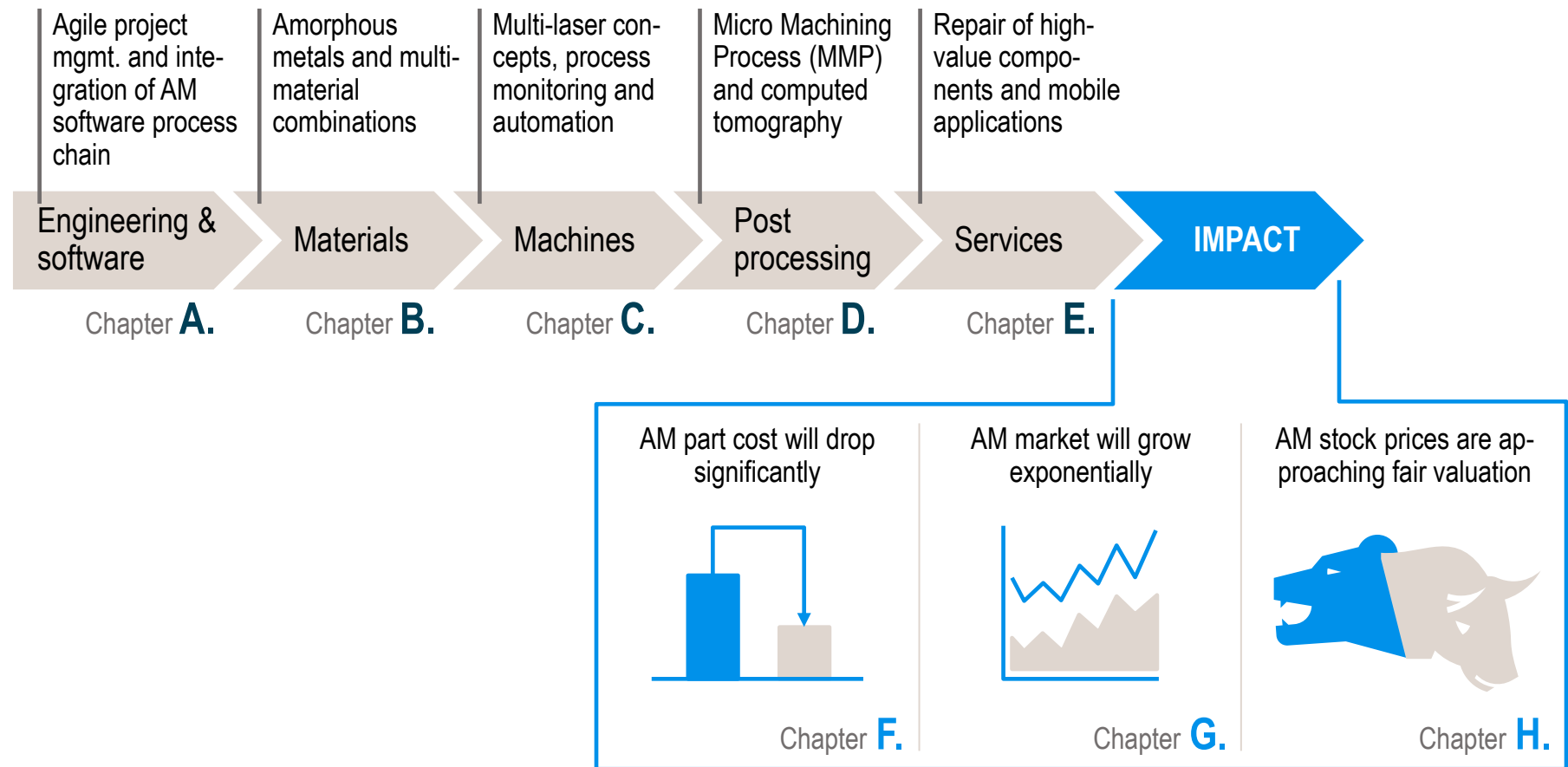

Roland Berger's Additive Manufacturing experts are at your service – Please don't hesitate to contact us!

Roland Berger's AM experts



**Dr. Bernhard
Langefeld**
Partner

Engineered Products & High Tech

Mobile: +49 160 744 6143
Email: Bernhard.Langefeld@rolandberger.com



**Hendrik
Veenker**
Senior Consultant

Engineered Products & High Tech

Mobile: +49 160 744 2296
Email: Hendrik.Veenker@rolandberger.com



**Dr. Christoph
Schäff**
Consultant

Engineered Products & High Tech

Mobile: +49 160 744 8248
Email: Christoph.Schaeff@rolandberger.com



**Christoph
Balzer**
Consultant

Engineered Products & High Tech

Mobile: +49 160 744 2937
Email: Christoph.Balzer@rolandberger.com

A. Engineering & software

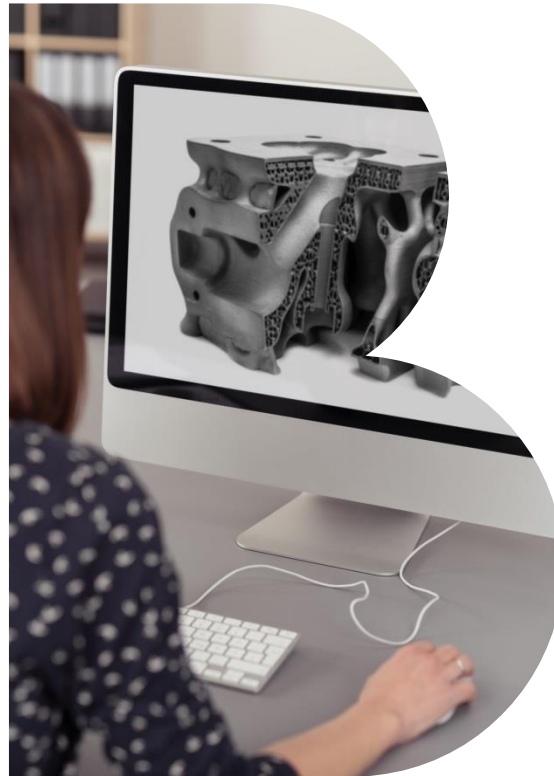

Additive Manufacturing – next generation (AMnx) is characterized by innovations along the entire AM process chain

Next generation ...

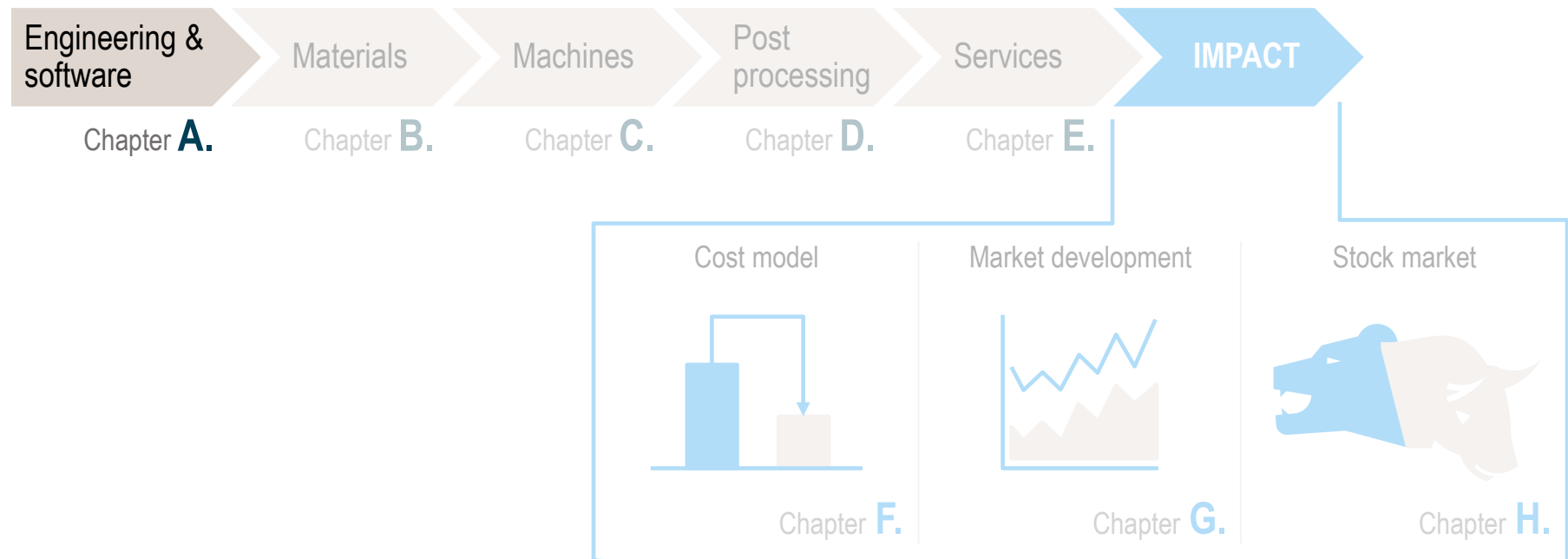

How will the fast availability of AM prototypes and the minor relevance of manufacturing impact new engineering processes?

Next generation engineering

Products

- > The value of mechanical components is falling in favor of software functionalities and automation technology
- > Overall relevance of software and number of software developers is rising
- > Production and information technology are merging closer together (resulting in Industry 4.0; Internet of Things)

Lifecycle requirements

- > Product lifecycle is getting shorter, sometimes even shorter than the development time
- > Rising number of variants per product
- > Trend toward mass customization

Engineering environment

- > Global engineering teams, working 24/7
- > Collaboration with external engineering suppliers
- > Rising complexity of customer requirements
- > AM simplifies formerly complex manufacturing processes ("CAD model = product")

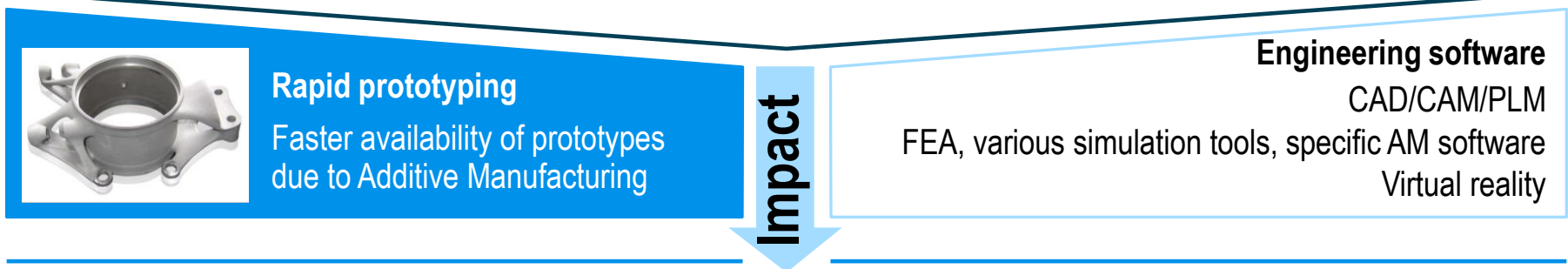

Will traditional engineering become more and more like software engineering due to the higher relevance of software in our products and the stronger support of software in AM development/manufacturing processes?

Additive Manufacturing makes agile project management methodologies more relevant for traditional engineering projects

Agile project management

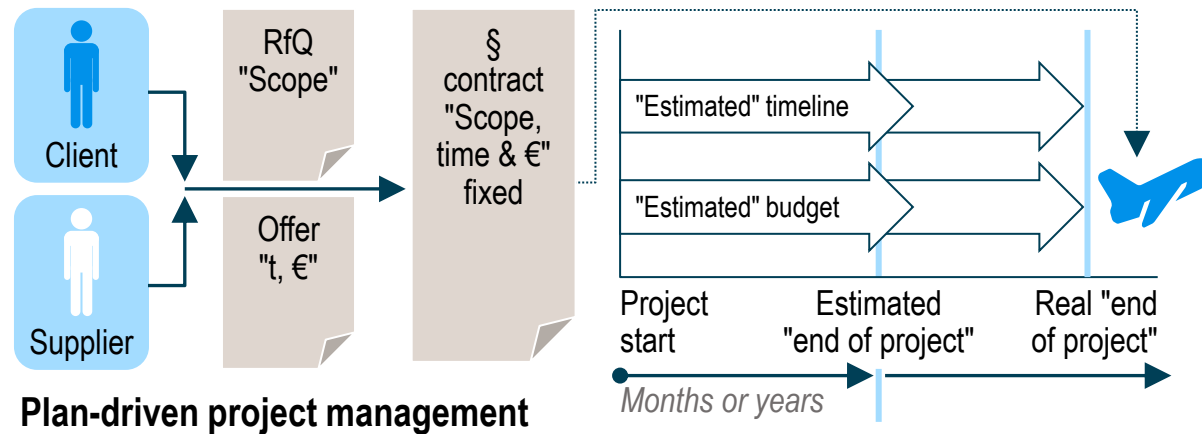

Characteristics

- > Although client and supplier have agreed on a specification, details are still uncertain or changes will emerge during the development process
- > The supplier can only estimate the time schedule and budget (resources) based on experience
- > During the (long) project duration the market demand and subsequently the scope can change

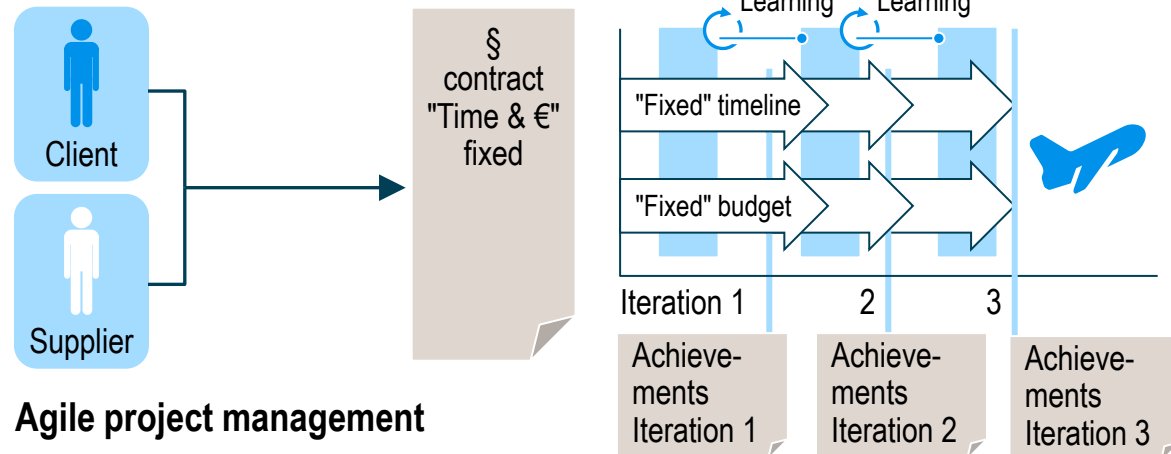

- > Timeline and budget are defined upfront as "fixed" elements and product owner and supplier agree on achievable outcomes per iteration
- > The product owner can change priorities from iteration to iteration depending on the market situation
- > Iterative results are verified by fast available prototypes from AM
- > Detailed specifications are created by the product owner only when necessary
- > Learnings are carried over from iteration to iteration

SCRUM is an agile project management methodology that breaks deliverables down into incremental sprint backlogs

Targets and principals of SCRUM

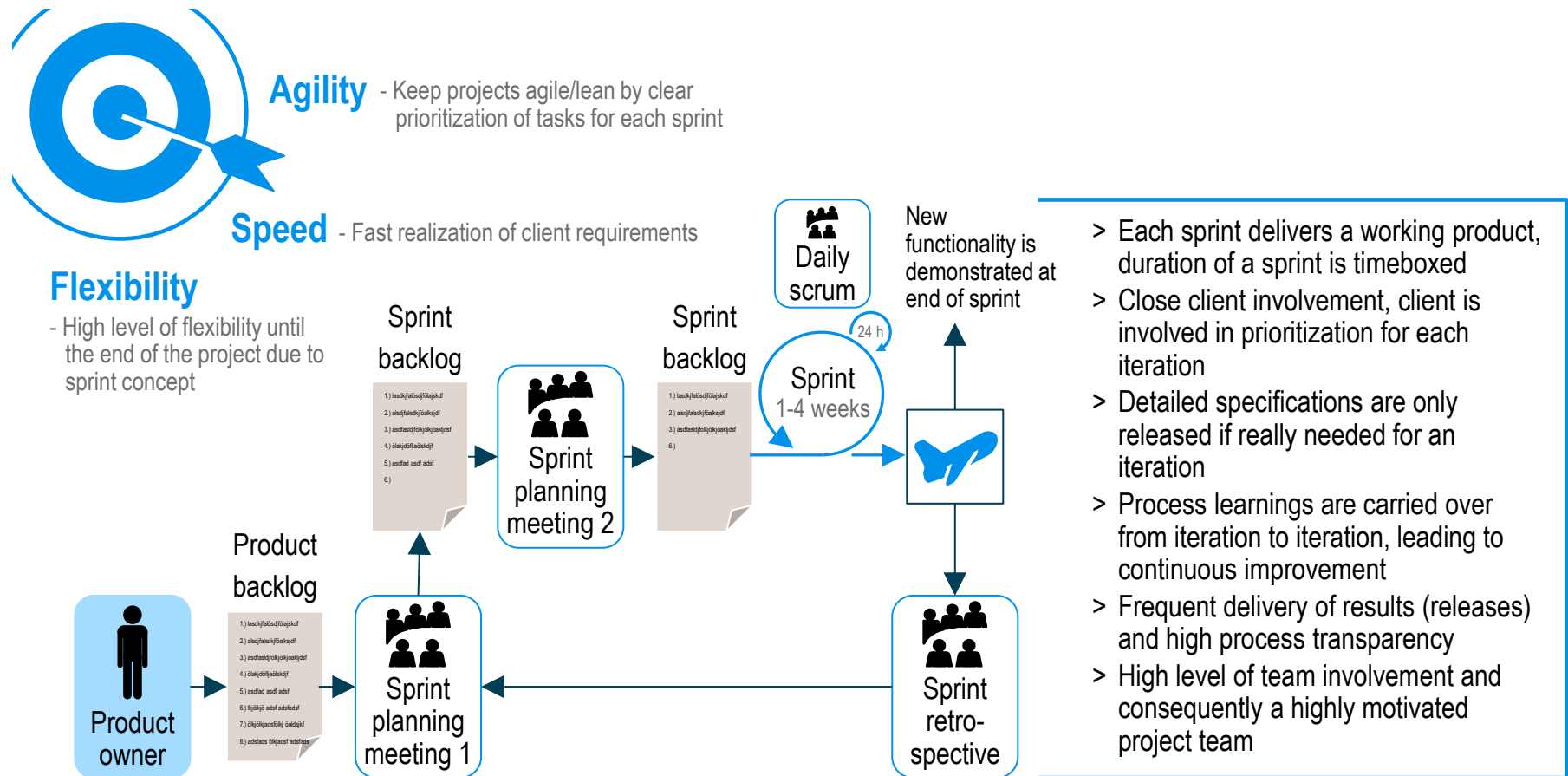

Initially developed for software engineering, SCRUM will have a huge impact on traditional engineering projects in the future

Key characteristics and facts about SCRUM

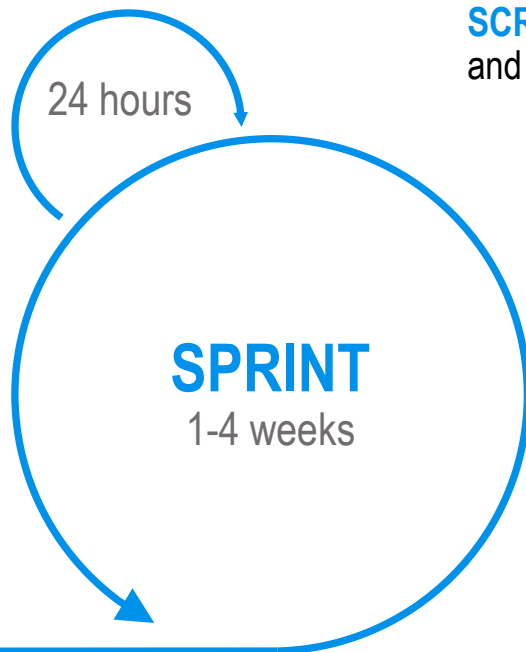

SCRUM was developed in the early **1990s** in the US and is today one of the most popular and well known **frameworks for software development**

SCRUM uses small self-organizing **teams** and is most efficient for **complex projects** with more than 4 developers

SCRUM consists of a clear set of **rules and roles**, supporting the **self-organization** and efficiency of the team – the roles are: Product Owner, Team and SCRUM Master

At the end of each **sprint** a working product that is 'really done' is available – the product is **reviewed by the whole team** and product and process learnings are carried forward into the next sprint

Sprints are of **fixed duration** and never extended – "**timeboxed**"

Additive Manufacturing will make the **SCRUM methodology** applicable to traditional engineering processes by providing (several, functional) **prototypes within a sprint iteration**

These **opportunities need to be reflected** in the processes and organization of **future engineering departments**



In order to develop AM-ready components, the conventional CAE¹⁾ needs to be complemented by specialized AM software

Typical AM software process chain

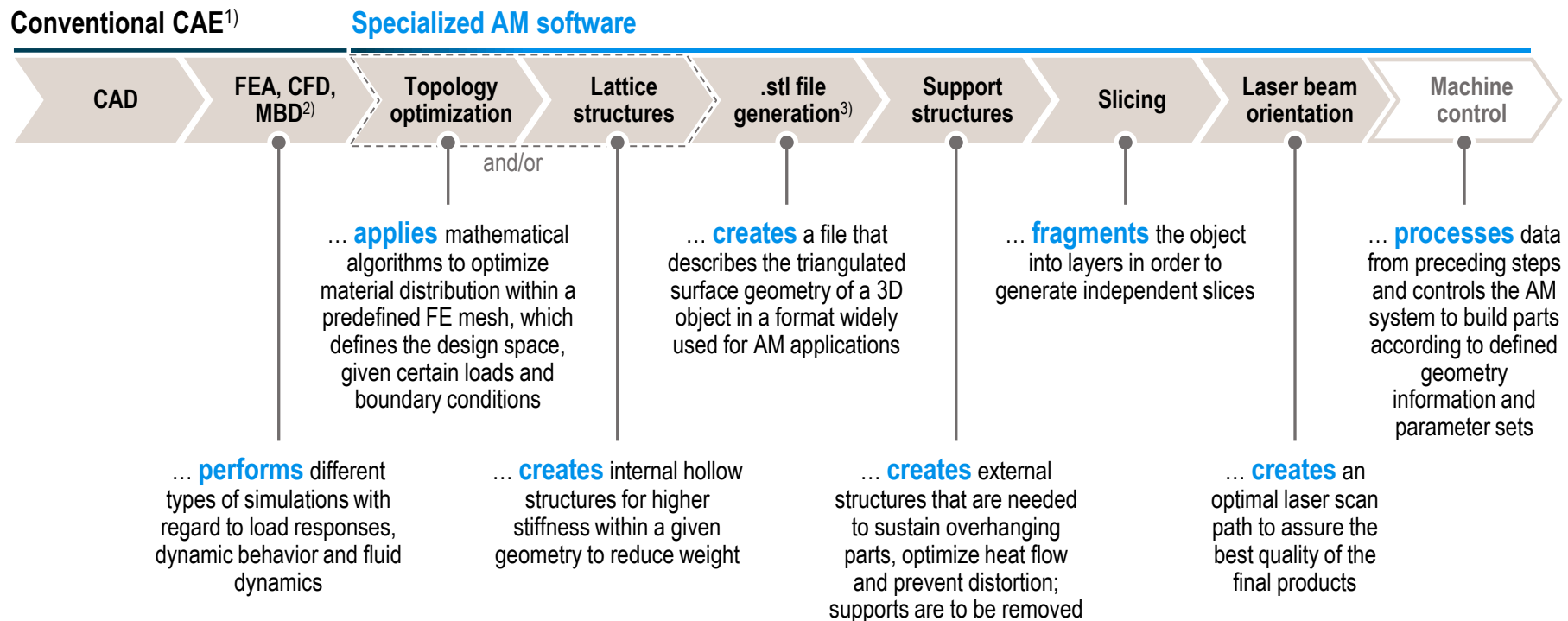

1) Computer-Aided Engineering 2) Finite Element Analysis, Computational Fluid Dynamics, Multibody Dynamics 3) Or other suitable format

Autodesk could become the first company to offer an all-in-one solution for AM through acquisitions of several software specialists

Autodesk's software portfolio in AM

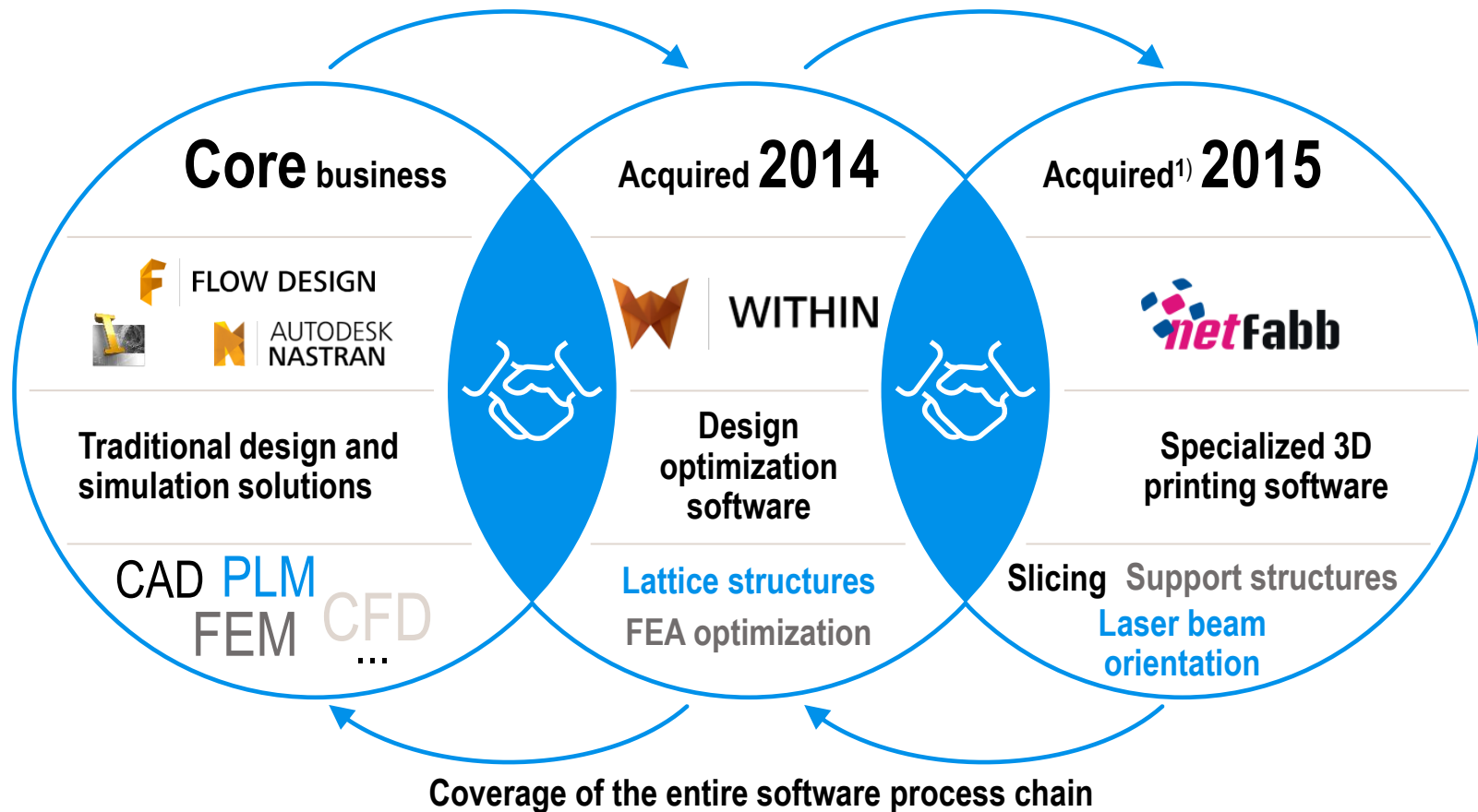

1) Definitive agreement to acquire netfabb signed in 2015, transaction expected to be closed in Autodesk's Q4 FY2016

Topology optimization & lattice structures software is available from different vendors – Level of sophistication varies by solution

AM software supplier landscape (sanitized, non-exhaustive)

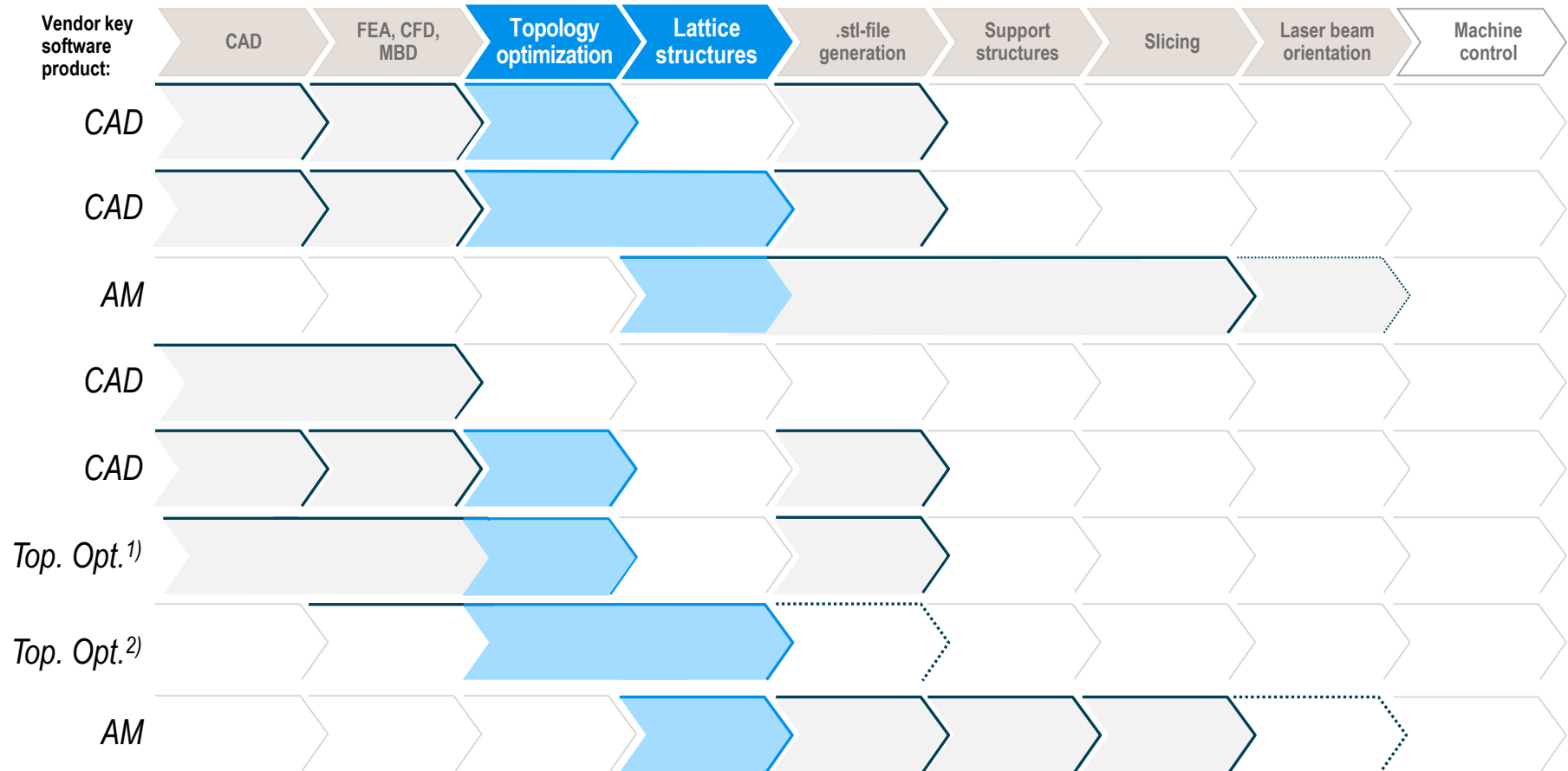

1) Topology Optimization 2) extended scope in partner alliance

The terms bionic design and topology optimization represent different approaches but can also go hand in hand in practice

Bionic design and topology optimization

The approach of bionic design...

- > **Evolution** has left most living organisms **highly optimized and efficient**
- > **Material** is only applied where **functionally required**
- > Instead of **solid parts**, combinations of a **surface** of varying thickness and a **porous structure** beneath can often be found
- > For example, the **bone of a bird** is highly lightweight due to large air cavities, yet very rigid
- > The systematic generalization and **transfer of suitable design principles observed in nature** to technical systems is often referred to as bionic design



Bone of a bird



Underside of a water lily



...compared to topology optimization

- > Topology optimizers apply **mathematical algorithms** to derive optimal designs with respect to given loads and boundary conditions
- > Resulting geometries can look **similar** to bionic designs
- > When it comes to very **fine structures**, the approach is limited by the highest feasible FEA mesh resolution
- > Findings from the field of **bionic design** can provide new **ideas and impulses** for the formulation of topology optimization problems, e.g. making it possible to **target certain design principles** as optimization results

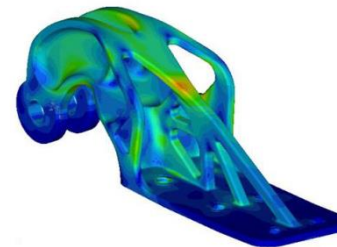

Topology optimized nacelle hinge bracket (Source: Altair/EADS)



Engine block with minimized material usage (Source: Autodesk)

Based on a finite elements model, topology optimizers propose a geometry that needs to be interpreted and implemented

Typical topology optimization process

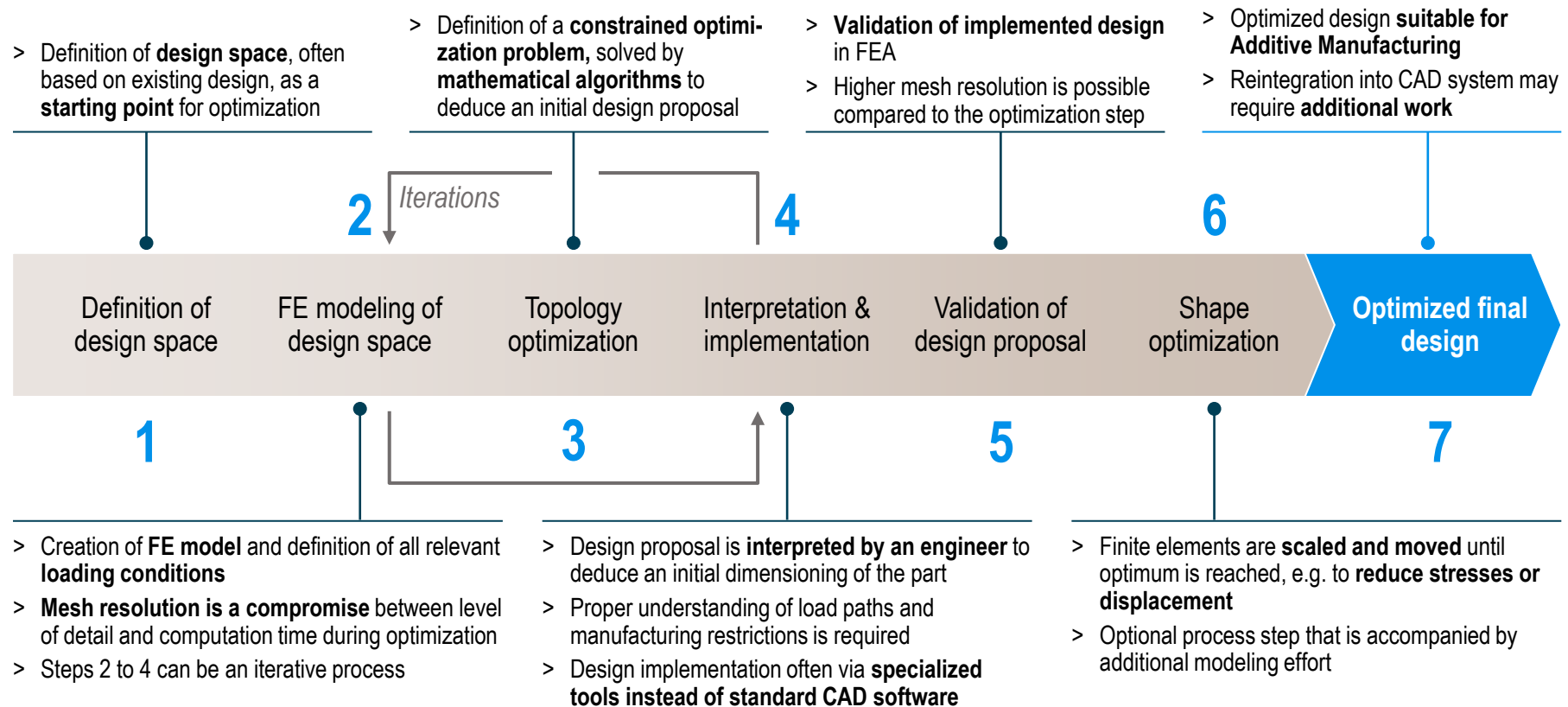

Altair ProductDesign redesigned a satellite component with weight reduction and stiffness in mind in a joint project with RUAG Space

Case study: Satellite antenna support arm (1/2)

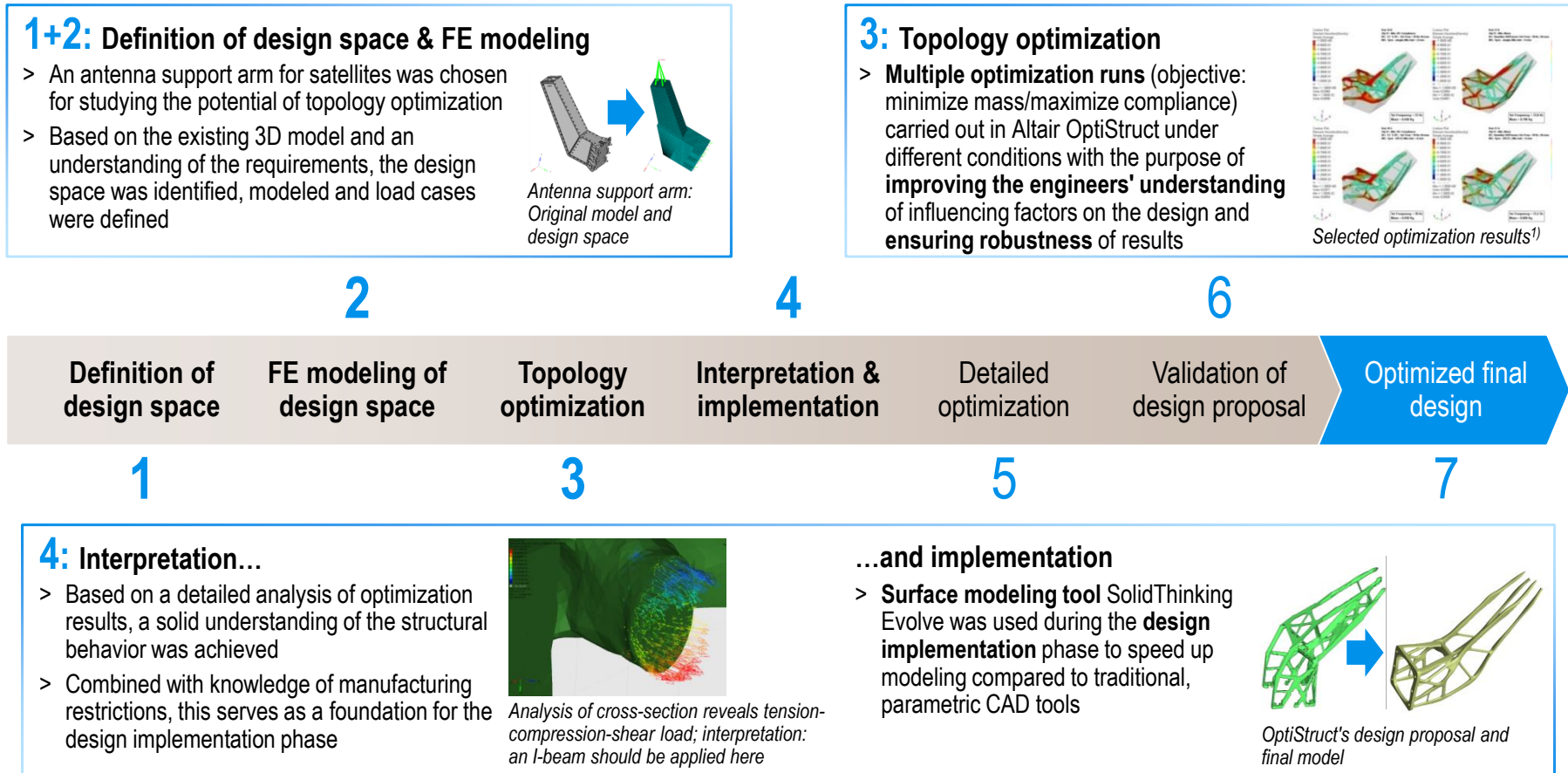

1) Color scale represents material density

Following further optimizations and a validation of the design, parts were manufactured on an EOS M 400

Case study: Satellite antenna support arm (2/2)

5: Detailed optimization

- > Instead of the shape optimization step, a **second topology optimization loop** was conducted to further improve the support arm's design

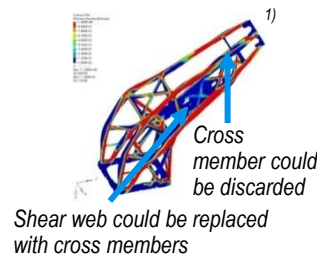

2

6: Validation of design proposal

- > A **second order mesh** was utilized for the verification step to achieve precise results
- > Aimed-for stress distribution levels and sufficiently high eigenfrequencies were reached while the required buckling load factor was comfortably exceeded

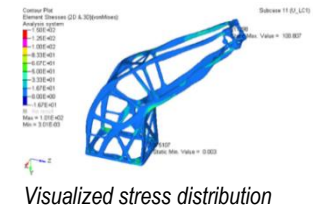

6



7: Additive Manufacturing of final design

- > Final design: Only **half the weight** at increased stiffness
- > Additive Manufacturing of antenna support arms on EOS M 400 system, followed by post processing
- > Destructive and non-destructive test campaign based on two samples was carried out successfully
- > **Parts are now ready for deployment**

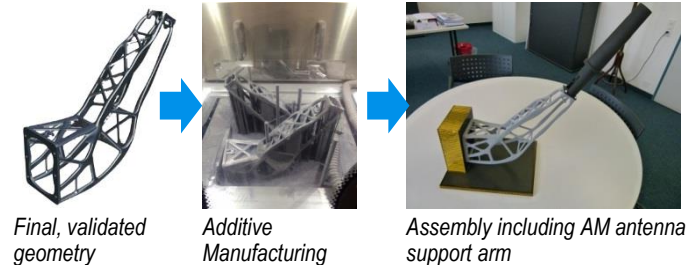

1) Color scale represents material density

Complex lattice structures offer potential for further optimization of weight against strength, rigidity and other, e.g. thermal, properties

Lattice structures

Principle

- > **Cellular lattice structures**, which are often only producible with AM, enable low weight, yet high rigidity due to application-specific patterns
- > Can also be used to create "**porous**" structures to approximate materials with **intermediate density** where suitable according to topology optimization results
- > A **plethora of different lattice designs** is conceivable, all yielding different mechanical and e.g. thermal properties
- > Different software is available with **varying degrees of sophistication**, from inserting predefined lattice structures to full control and simulative study or optimization functionality
- > Lattice structures are highly **advantageous for medical applications** (osseointegration) but can be **problematic in aerospace environments** due to certification, inspection and maintenance requirements



Lightweight bracket with lattice structures (Source: Materialise)

Advantages of lattice structures

- ✓ Reduced part weight
- ✓ Detailed control over mechanical properties
- ✓ Freedom in placement of the center of gravity
- ✓ Optimization of heat flows
- ✓ Reduced powder material consumption
- ✓ Reduced component build time

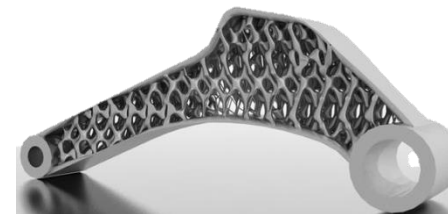

Bracket that has been weight-optimized with lattice structures (Source: Autodesk)

To fully utilize the disruptive potential of AM as a new production technology, a rethinking of the engineering process may be required

Potential future AM software process chain: Simulation-driven engineering

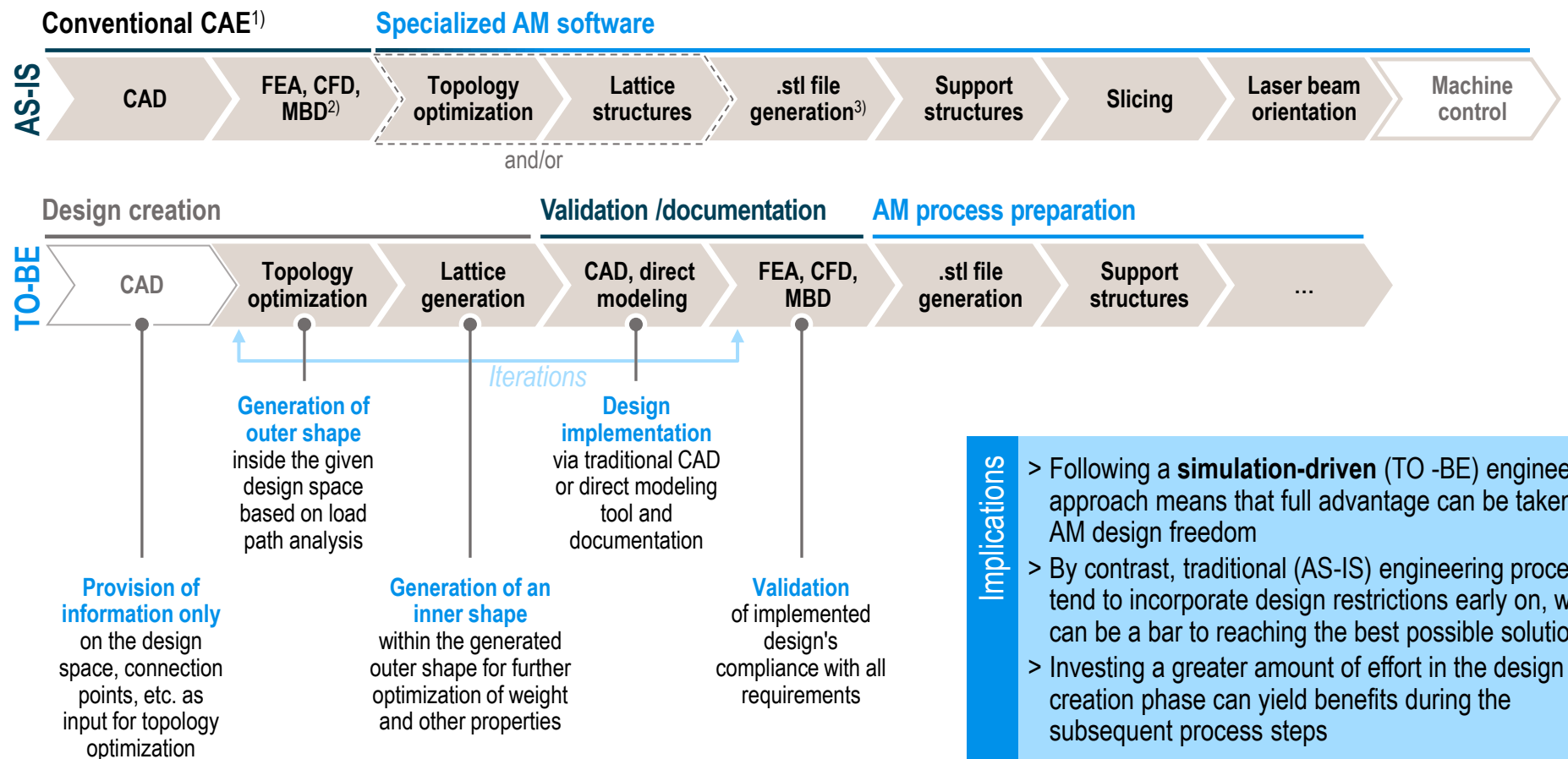

Engineering needs to be viewed as an integral part of the AM process

– First integrated software platform concepts already available

AM software platform

Streamatics™

- > Open software platform to manage and control the AM production process
- > AM technology & machine type independent
- > Proven solution in manufacturing
- > Integrated with Materialise software solutions to increase efficiency, ensure lifetime traceability, guarantee repeatable quality and enable sustainable growth of AM production
- > Platform offers AM machine monitoring & logging, part labeling automation and optimal build platform preparation & production scheduling

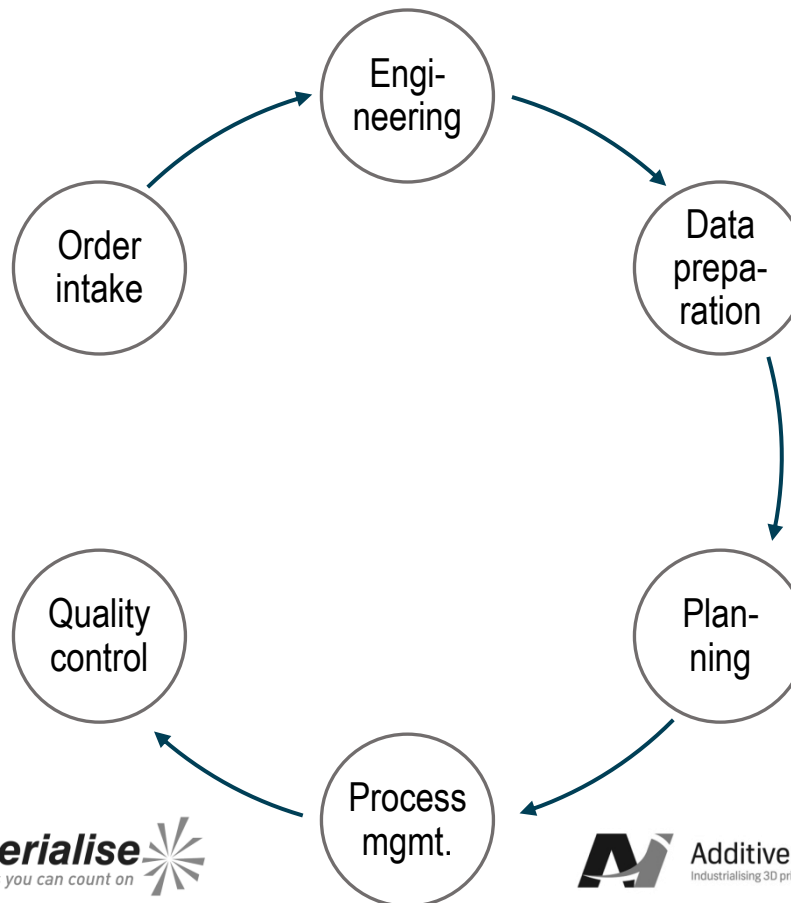

Additive World

Platform

- > Software to support the end-to-end AM process including pre and post processing
- > Data storage in the cloud or locally allows the centralized and efficient management of designs, build/part data, settings, planning, print process, test data & results
- > Solution is designed to fully integrate with Additive Industries MetalFAB1 system and allows for remote factory management and distributed e-manufacturing
- > Open platform offers a generic interface (API) to other equipment and applications and is validated in regulated series production



B. Materials



Additive Manufacturing – next generation (AMnx) is characterized by innovations along the entire AM process chain

Next generation ...

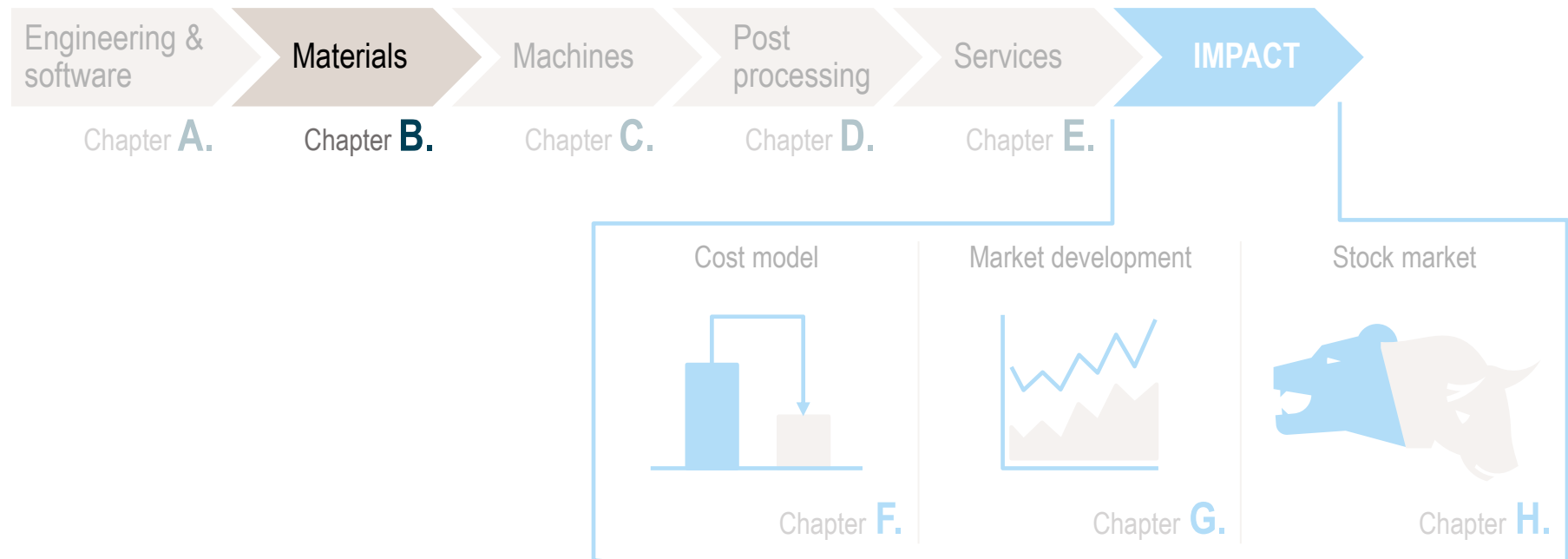

Amorphous metals offer a unique combination of material properties due to their atomic structure

Amorphous metals: Introduction

Metallurgical process

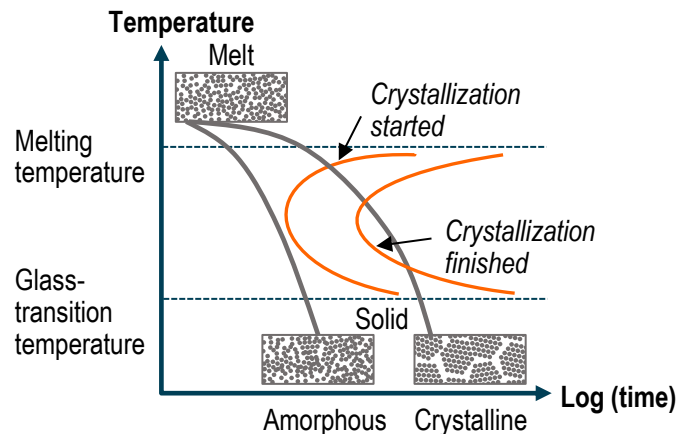

- > Alloy with suitable **glass-forming ability** needed to produce amorphous metals, e.g. Fe-, Zr- or Ti-based
- > High cooling rates lead to amorphous (non-crystalline, i.e. disordered) atomic structure
- > Achievable cooling rate limits **maximum material thickness** with traditional manufacturing methods, e.g. casting
- > The amorphous atomic structure determines specific material characteristics

Mechanical properties

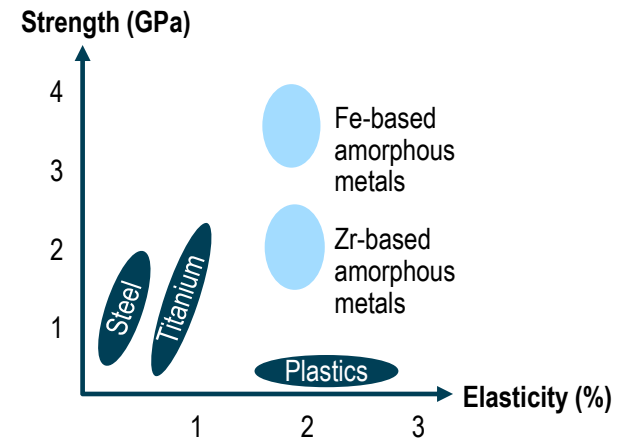

- > Amorphous metals combine **high strength and high elasticity**
- > They offer high hardness, corrosion resistance, conductivity, biocompatibility and self-sharpening properties
- > **Ductility and fatigue strength** are typically below that of crystalline metal – research has shown that fatigue strength can be improved by reinforcing amorphous matrix with nanocrystals
- > Ferromagnetic amorphous alloys furthermore offer **high magnetic susceptibility with low coercivity** and high electrical resistance

Additive Manufacturing has the potential to enhance the applicability of amorphous metals by overcoming current constraints

Exmet: Additive Manufacturing of amorphous metals

Additive Manufacturing of amorphous metals

- > Traditional process requires **specific glass formers** to enable significant material thickness (> 1 mm, "bulk metallic glass")
 - Commercially available glass formers today are often **costly** and problematic due to their **hazardous** nature
 - Thickness constraints (critical casting diameter) can only be **mitigated** by these glass formers, not completely overcome
- > Exmet has developed a **new method** to build parts of virtually **any thickness** and geometry out of amorphous metals **using Additive Manufacturing**
- > Only a small volume is melted at a time which makes it possible to control cooling rates in new ways compared to casting
- > Project currently in **commercialization phase** in cooperation with industry partners – **first prototypes expected 2016**

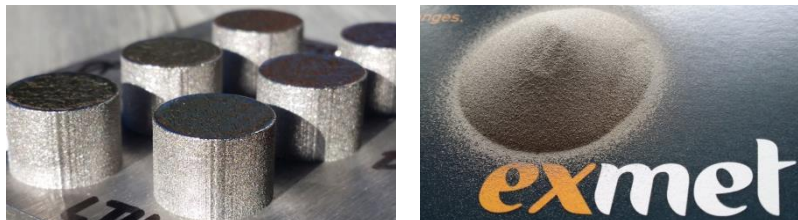

Amorphous metal samples produced with AM and Exmet metal powder

Limitations

- > Technology still **approx. 2 years from commercial stage**
- > Exmet currently focuses on **Fe-based powders**, which are **cheap and non-toxic**
- > Application temperature is limited to 550-600 °C for Fe by glass-transition temperature T_g

Benefits

- > **No theoretical limit to maximum thickness** while maintaining advantageous material properties of amorphous metals
- > **No hazardous elements as glass formers** necessary
- > **Low process cost achievable in the long run**, comparable to AM of traditional metals
- > **Low powder prices** possible once volumes are high enough since method enables the utilization of **Fe-based powders**
- > Works with **laser and electron beam PBF**

Amorphous metals are pushing into new application areas – AM-based production method might boost adoption rate

Amorphous metals: Application areas¹⁾ and potential of Additive Manufacturing

Simple application areas

- > Well **established and commercialized** (if still partly niche/high end) application fields for amorphous metal
- > **Often low share** of amorphous metal in total product, e.g. only front surface of golf club



Golf clubs



Cell phone parts



Jewelry



Amorphous metal knives

New application areas

- > New application areas are already **accessed in part** using sophisticated materials engineering approaches
- > Higher share of reliance on **expensive** and sometimes **problematic** ingredients and processes currently **limit market potential**

Example

Description



Electronics

- > New distribution transformers and electrical motors with amorphous metal components (low coercivity) decrease energy losses (hysteresis losses)



Aerospace

- > Amorphous metal parts for space applications
- > Due to their magnetic properties they are e.g. suited for solar wind collectors



Mechanical engineering

- > New mechanical engineering parts made of amorphous metals, e.g. more resilient suspensions

Additive Manufacturing has the potential to make these and other applications more economical/ecological and to spread the use of amorphous metals **beyond today's application areas**

1) Non-exhaustive

UK technology start-up Metalysis invented a shortened production process for metal powder using electrolysis

Metalysis process vs. traditional process

Comparison of process steps

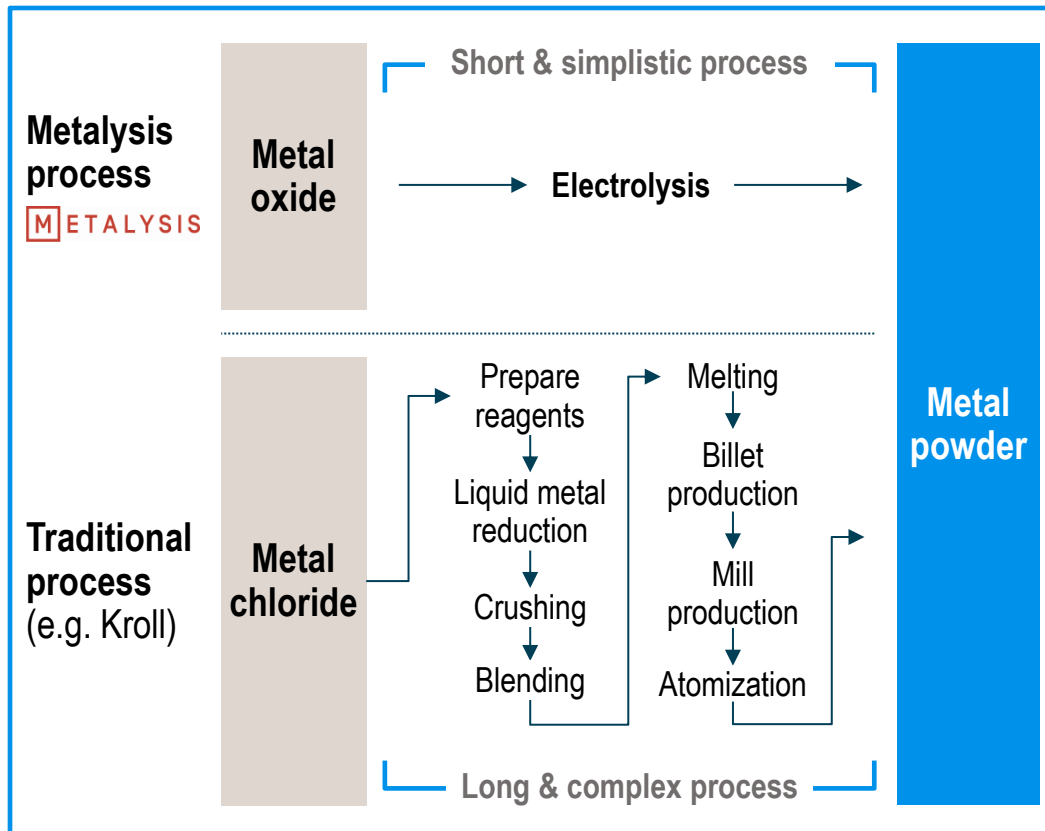

Benefits of Metalysis process

- ✓ **Clean technology**
 - > No toxic byproducts, lower energy consumption and reduced CO₂ footprint
- ✓ **Cost effective**
 - > Fewer process steps – lower investment and operating cost
 - > High yield process with tailored particle sizes
 - > Cost reduction of 75%+ conceivable
- ✓ **Transformational**
 - > Solid-state alloying: ideal for different densities and melting points

> Metalysis are engaged in a development project with GKN Aerospace for aerospace-tailored titanium alloy AM powder

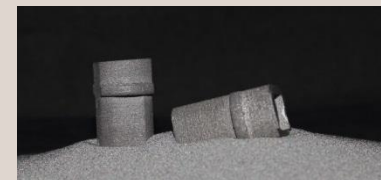

Demonstration component for an automotive turbocharger made from Metalysis titanium powder, produced on a Renishaw PBF machine

Multi-material manufacturing processes are emerging for current and next generation PBF technologies

Types of multi-material parts

1 Discrete material transition

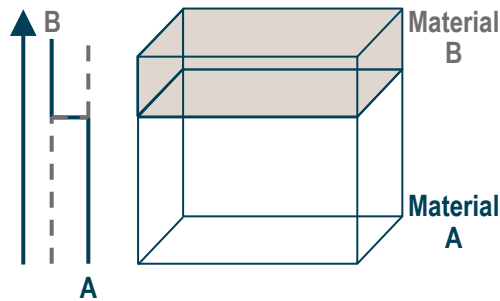

- > **Exchange of materials by interrupting the AM process**
- > **1-dimensional material transition**
- > **Discrete material boundaries** between manufactured layers
- > **Time consuming** processes, e.g. due to exchange of materials (change reservoir, clean chamber, etc.) or transfer to a different chamber/machine

2 Continuous material transition

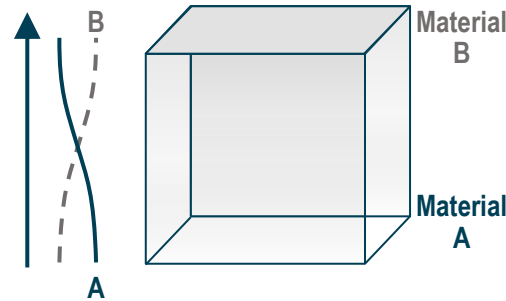

- > **Online exchange of materials** while the AM process is running **without interruption**
- > **1-dimensional material transition**
- > **Continuous transition** between materials
- > **Mixing of materials** in powder bed pool presents **difficulties for material reuse**

Multi-materials at full complexity

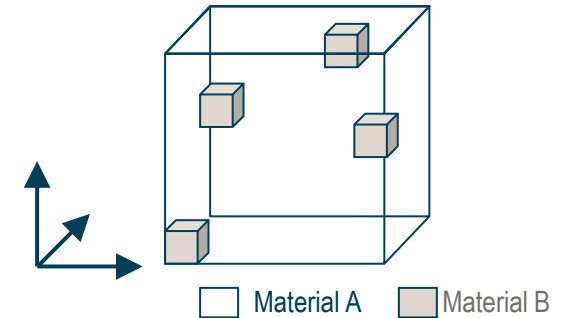

- > **True multi-material part manufacturing:** printing of any **3-dimensional multi-material structure**
- > **Not realizable with current powder deposition methods** due to the nature of the fabrication process

1 Discrete material transition

IQ Evolution's multi-material approach allows for highly optimized parts with locally tailored material properties

Discrete material transition

Principle

- > Parts are manufactured using **multiple materials**
- > During manufacturing the part is **transferred into a second AM chamber** (using a second base material)
- > Materials can be selected based on specific needs (e.g. thermal conductivity or other physical properties):
 - **Nickel, chromium, titanium**, stainless steel, etc.
 - Special **alloy composite** materials
- > **Compatibility of material characteristics** required

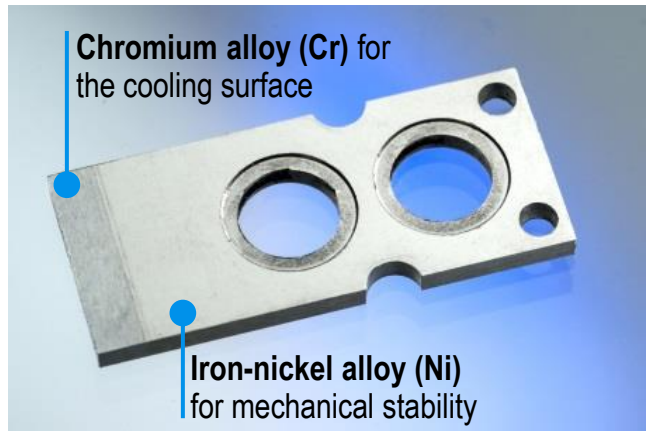

Micro-channel cooler for high-power diode laser applications

Application

- > **Micro-channel cooler¹⁾ for high-power diode laser applications with demanding requirements:**
 - **High thermal conductance** near diode lasers
 - **High mechanical stability** near the mounting base
 - **Matching thermal expansion** coefficients
 - High **corrosion resistance** against coolant fluid
- > **2 materials approach** to optimize the part's local properties:

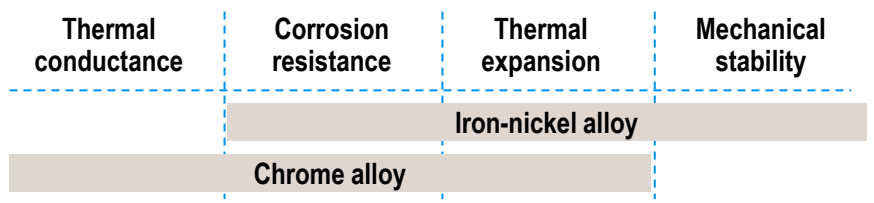

Result

> **Multi-material parts with locally optimized part properties** have become **commercially available** and are incorporable into standard AM production processes

Material properties match part requirements

1) Registered patents: US 9083138; US 12438336; EP 1672690; EP 2061078

IQ Evolution's system for online exchange of powder material allows for continuous material transitions during part manufacturing

Continuous material transition

Concept demonstration

- > **Continuous material transitions** between different materials **in a single part**
- > Potential to realize **sequences of complex material transitions**, e.g. the transition in the figure below starts with a continuous transition from NILO¹⁾ to copper followed by a discrete transition back to NILO¹⁾

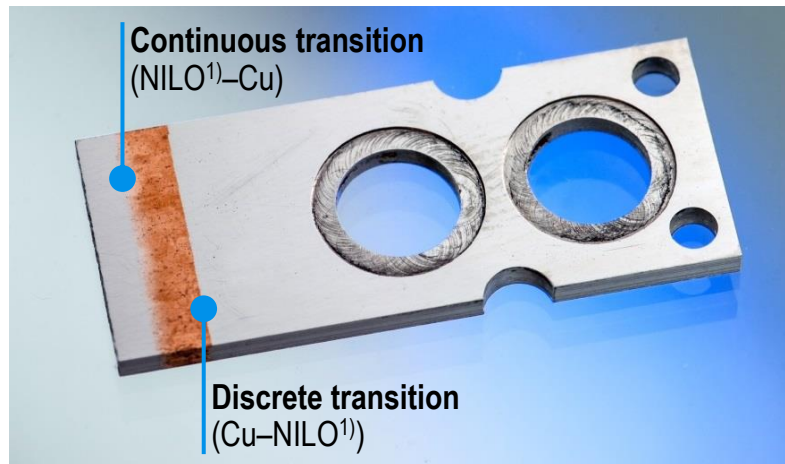

Demonstration of a continuous material transition; incorporated into a micro-channel cooler structure for demonstration purposes²⁾

Principle

- > A **powder control system** manages powder provision to the PBF machine
- > The system allows **up to 3 materials** to be combined **in any ratio**
- > **Mixing ratios** can be **controlled and changed over time** during the manufacturing process ("online")
- > **Online exchange** of powder materials during the manufacturing process allows the creation of a **continuous material transition**

Result

- > Potential to manufacture **arbitrary continuous multi-material transition structures** and sequences
- > **No additional manufacturing time** required
- > **Local part properties customizable** for specific functions
- > **Higher compatibility** of different materials is achieved due to the continuous material transition (in comparison to discrete transitions)
- > System currently **in development stage**, application-specific advantages to be verified

1) Tradename NILO: Nickel-iron alloy with low thermal expansion coefficient (variant of Invar) Registered patents: US 9083138; US 12438336; EP 1672690; EP 2061078

C. Machines

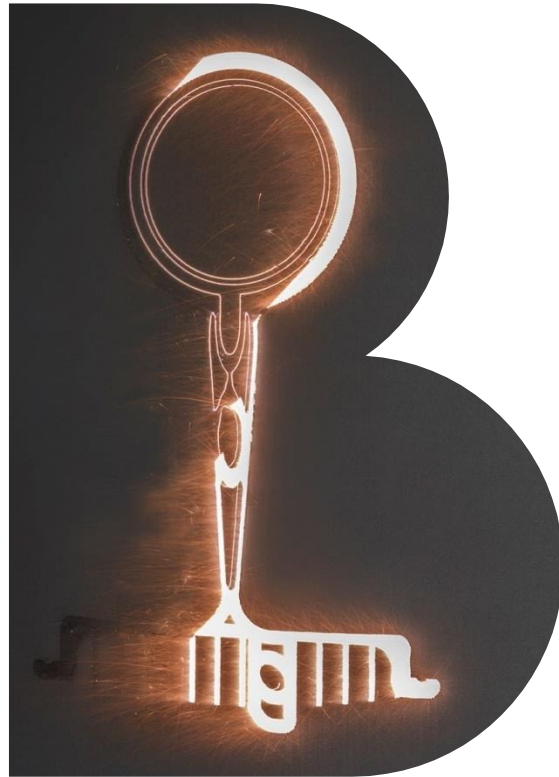

Additive Manufacturing (AMnx) next generation is characterized by innovations along the entire AM process chain

Next generation ...

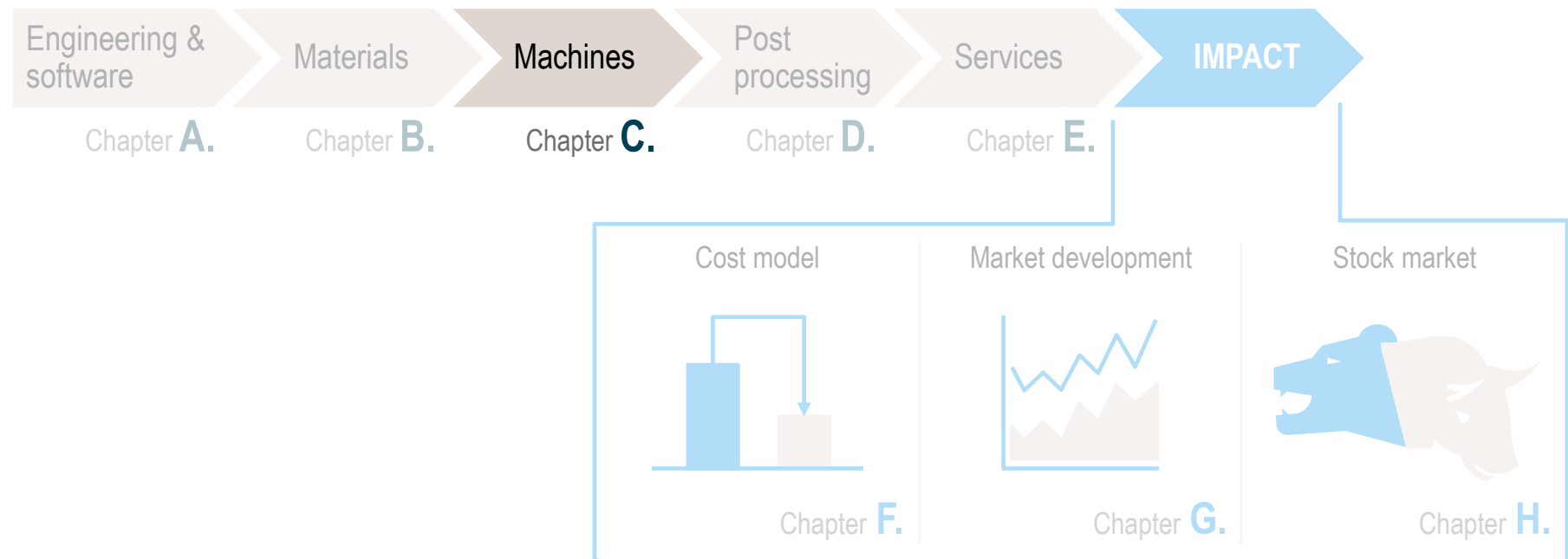

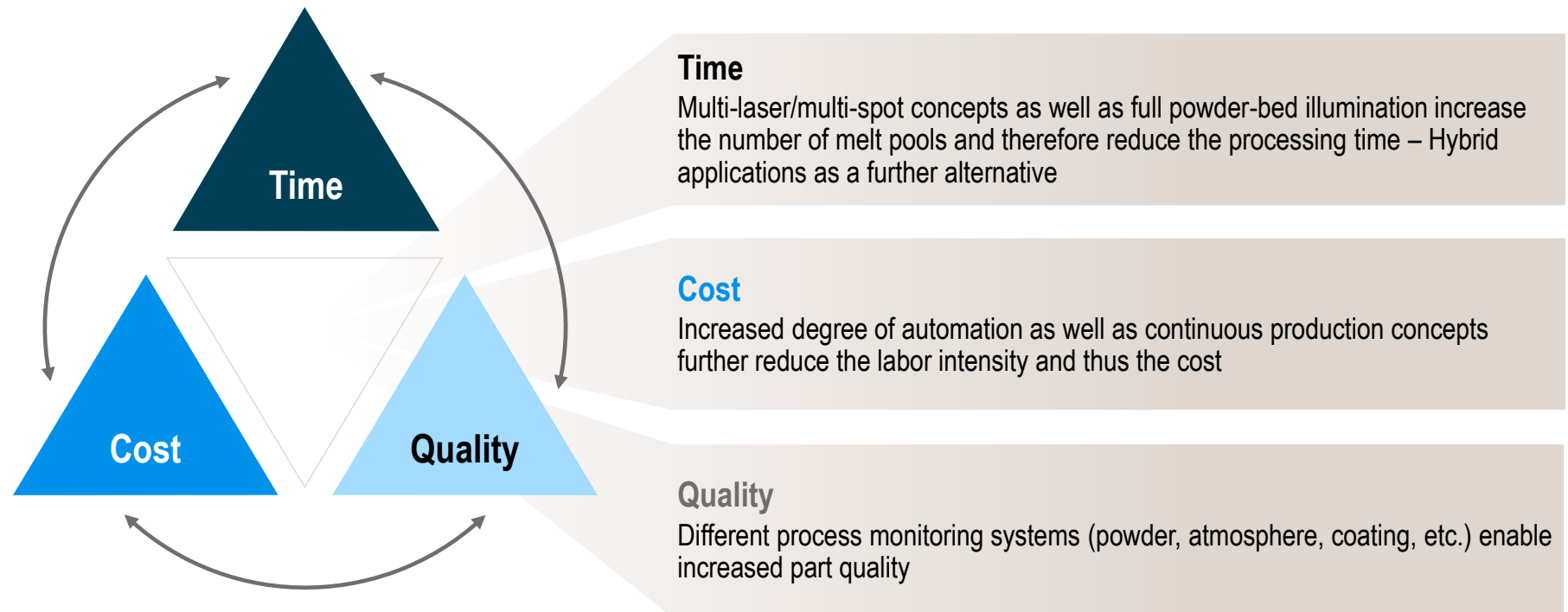

Next generation Additive Manufacturing systems will approach an optimum in the triad of time, cost and quality

Trends

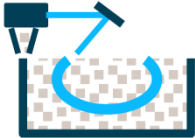

Common single-laser PBF techniques exhibit limitations in terms of manufacturing speed – Fundamentally new approaches emerging

Existing and emerging PBF concepts

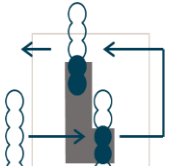
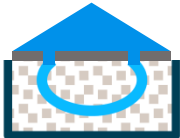
Concept	Description	Status
Common PBF concept 	<ul style="list-style-type: none"> > Standard AM systems use a single laser and optical scanning system to focus the laser on the powder bed area via movable optical devices > Limited chamber size, e.g. due to difficulty maintaining uniform conditions over the chamber area or optical system limitations¹⁾ 	Standard system
Multi-laser/laser heads concepts 	<ul style="list-style-type: none"> > Multi-laser systems (currently up to 4 lasers available) for independent/ simultaneous laser operation and increased layer-by-layer process speed > Laser head as the most expensive part limits multi-laser potential > Requirement to maintain constant chamber conditions in a multi-laser system limits scalability (e.g. due to fume creation, constant atmosphere) 	State of the art
Multi-spot array concepts 	<ul style="list-style-type: none"> > Multi-spot array mounted on a printer-like processing head resulting in low-cost system not limited by chamber size > Potential drawbacks vs. beam-steering approach for complex/small structures 	Next generation
Full powder-bed illumination 	<ul style="list-style-type: none"> > Simultaneous illumination of complete powder bed > Contour forming, e.g. through application of radiation-sensitive chemical agents > Method in research stage, feasibility for metal materials to be evaluated 	

1) Far away from the center axis of the optical system imaging errors increase and the laser spot cannot be imaged correctly, which negatively impacts the manufacturing quality

Current AM systems utilize multiple lasers to increase productivity and reduce manufacturing time

Multi-laser concept – The current state-of-the-art solution

Principle

- > AM production time depends on the layer-by-layer laser exposure time, lowering of the chamber platform and powder-bed distribution time
- > Using multiple independent lasers, different areas can be manufactured in parallel with direct impact on exposure time
 - E.g. dual-laser systems halve the exposure time leading to an overall productivity increase by a factor of 1.8



Image of the manufacturing chamber of SLM Solution's SLM 500^{PL} system capable of using 4 independent lasers and scanner systems simultaneously

Realization

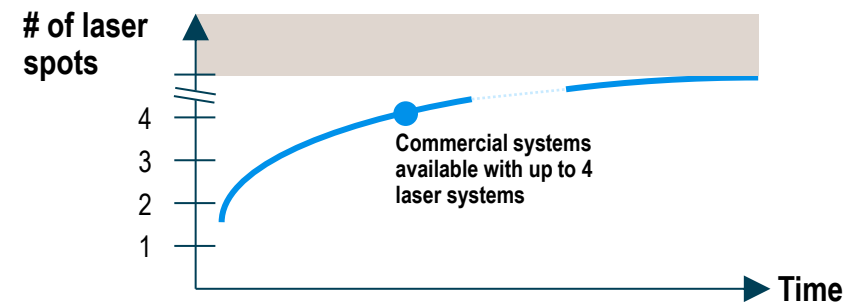

Result

- > A higher number of laser spots yields a direct increase in manufacturing speed
- > Nevertheless, multi-laser technology faces some problems, e.g.:
 - The laser system is the system's most complex and expensive component
 - Heat and fume creation scales with the number of laser spots and limits the manufacturing process
- > Limited advantage of multi-laser technology: scaling of the system with the most complex and expensive component fundamentally limits the method's cost advantage

ILT's multi-spot system represents a conceptually new approach – Direct advantages in process speed and system cost

Multi-spot array concept – Next generation technology

Principle

- > A 5-spot **laser array** is mounted **on a single printer-like processing head**
- > **5 diode lasers** are **coupled** to the processing head **via an optical fiber system**
- > The processing head **moves** over the powder bed **similarly to a paper printer head**
- > A **local shielding gas and fume removal** system is mounted **directly on the processing head**
- > **Melt pool control** is achieved **by laser intensity modulation** while the processing head moves over the powder bed (see figure below)

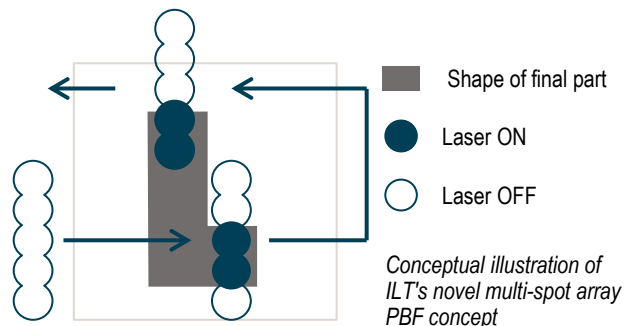

Realization

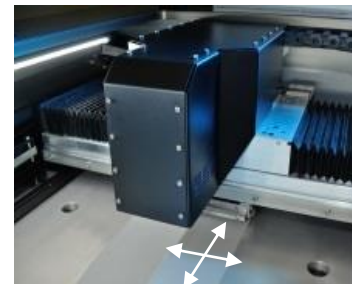

Picture of the enclosed ready-to-use PBF multi-spot system



View of the processing head: a five-spot array is mounted on a single scanning head

Result

- > **Good scalability** in terms of manufacturing speed and chamber size:
 - **Increased manufacturing speed** due to a wider area of optical illumination
 - **Chamber size is not limited** by the optical system
 - Local shielding gas and fume removal system for **ideal processing conditions independent of chamber size**
- > **Reduced system cost** due to a low-complexity optical system



System currently in **research stage**, part quality to be evaluated – potential drawbacks vs. beam-steering approach for small structures

HP's Multi Jet Fusion technology as a first step toward full powder-bed illumination – Feasibility for metals under evaluation

Full powder-bed illumination concepts

Principle

- > **Application of fusing agent (F)** across powder bed using a printer-like arrangement through a thermal inkjet array
- > A **second chemical agent (S)** is applied, e.g. to **selectively reduce or amplify fusing** process leading to sharper boundaries/edges
- > **Contouring by mask-like application of agent instead of controlled laser radiation** optics
- > Uniform, powder-bed-wide **exposure with energy radiation (E)** leads to **fusing** of materials **where agent has been applied**
- > **Repeat process layer by layer**

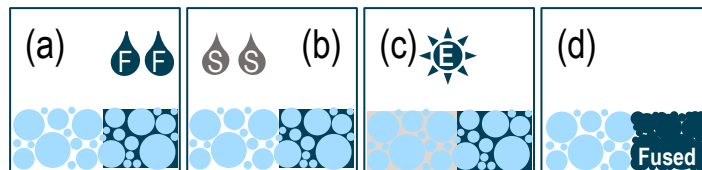

Principle of HP's novel AM technology; "F" and "S" refer to fusing and second chemical agent respectively

Realization



Manufactured plastic-based parts with the potential of using color-pigmented ink (right); Copyright HP

Potential

- > **Feasibility for ceramics and metals under evaluation**, difficulties due to required high illumination power for metals
- > **Commercial system for thermoplastic material** to be released in 2016
- > **Faster manufacturing speed** compared to other AM methods; up to 10 times faster according to HP
- > 30 nozzles allowing for **250 million drops per second at 21 μm precision**
- > **Accurate placing of chemical agents** with potential for **influencing local material properties** (color, opacity, surface roughness, elasticity, etc.)



System currently in **development stage**, precision, specifications and feasibility for metals to be evaluated

Hybrid applications combining AM and metal cutting could be an alternative concept – Higher build rates and lower cost possible

Hybrid applications (1/3)

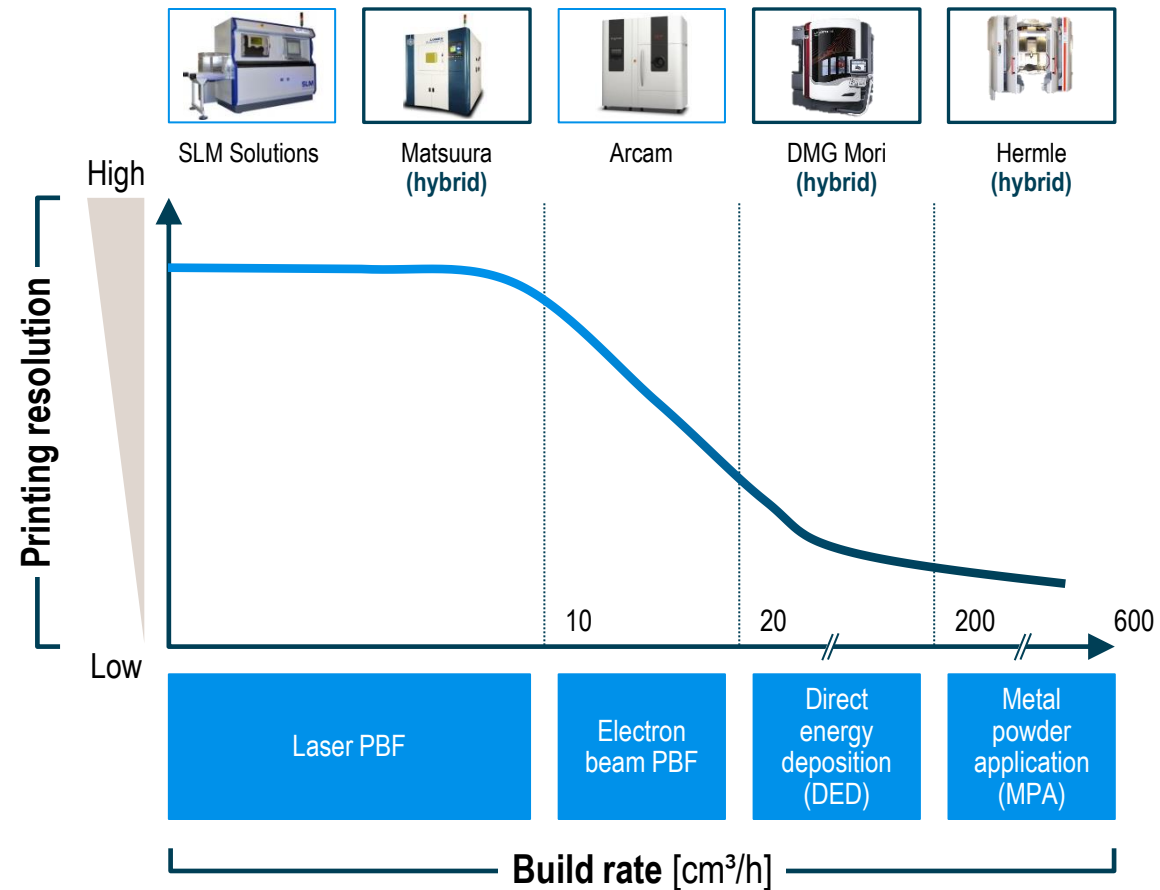

- > Hybrid systems typically result from the integration of **generative manufacturing techniques** into existing **machine tool concepts**
- > Concepts try to **integrate the whole manufacturing process** into one process step only – significant **complexity reduction** in production as a key benefit
- > **Build rates** of hybrid systems are **up to 60 times higher** than conventional PBF – manufacturing cost are therefore significantly lower
- > **Large build chambers** allow production of large, mostly rotationally symmetric components
- > Even combinations of laser PBF and machining possible (Matsuura)

Hybrid applications have certain advantages for particular applications – German machine tool suppliers leading

Hybrid applications (2/3)

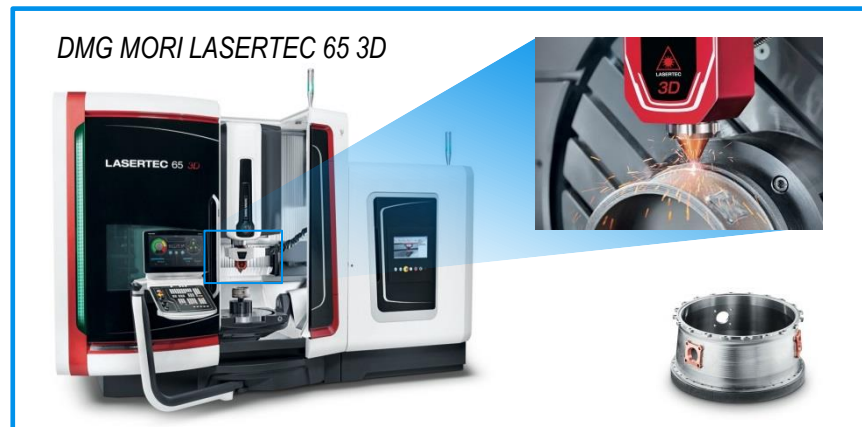

- > Combination of direct energy deposition (DED) AM system with a **five-axis milling machine**
- > Based on a DMU 65, developed with SAUER LASERTEC
- > According to DMG MORI a **build rate 10 – 20 times higher** than powder bed fusion machines can be achieved
- > 2.5 kW diode laser
- > Materials: steel, cobalt alloys, brass, nickel based alloys, tungsten carbide
- > **Combination of different material layers possible**

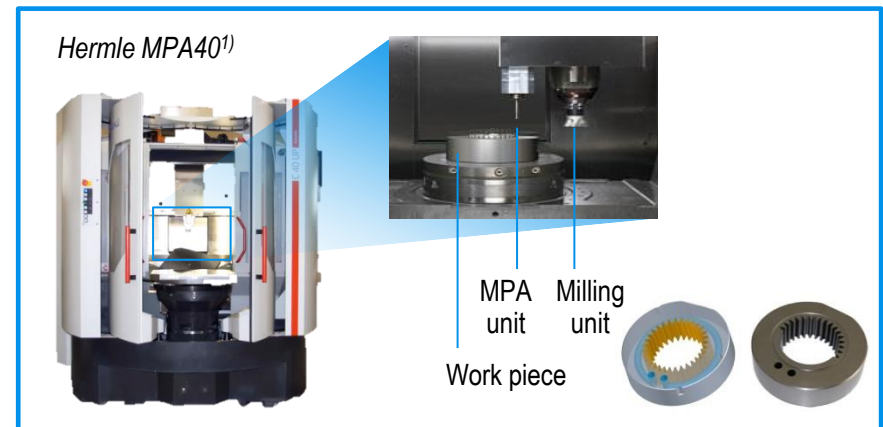

- > **MPA** is a thermal metal coating process generating components by **kinetic compacting**
- > **Thermal treatment necessary** to optimize grain structure
- > All standard metal powders can be used and combinations of different powders are possible
- > The **build rate** is > 3.3 cm³/min, i.e. **much higher than PBF by electron beam or laser**
- > Hollow structures and undercuts are also possible by using a water dispensable filler material

1) MPA material application unit is integrated into a Hermle 5-axis machining center of type C-40

Hermle's MPA technology is a thermal spray process that compacts metal powder layer by layer to massive objects

Hybrid applications (3/3) – Hermle MPA

Operating principle

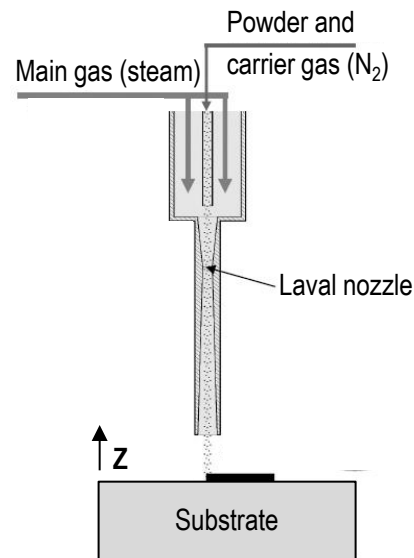

- > Acceleration of main gas in Laval nozzle
- > Injection of powder particles just before Laval point and acceleration to supersonic speed
- > Powder particles are not fused – energy input into the component

Advantages

- > Very high build rates of > 3.3 cm³/min
- > Several materials available, incl. steel (1.2344, 1.2367, 1.2333, 1.2379, 1.4404, 1.4313), copper, bronze and titanium
- > Combination of different materials (e.g. steel and copper, see picture on right) possible
- > Good material constants (1.2344: tensile strength ~ 1,750 MPa / roughness depth R_a 0.005 μm)
- > Hollow structures and undercuts are possible by using a water dispensable filler material (see case study)



Case study – Production of cooling channels



1) Milling of cooling channel in raw material



2) Filling of channel with water-soluble material



3) Application of tool steel to the lateral surface



4) Dissolving of carrier material in cooling channel

1) In the direction of the nozzle (z)

EB¹⁾ gun with 10 kW power developed by Arcam – beside titanium, titanium aluminide and super alloys as new materials

Electron Beam Melting (EBM)

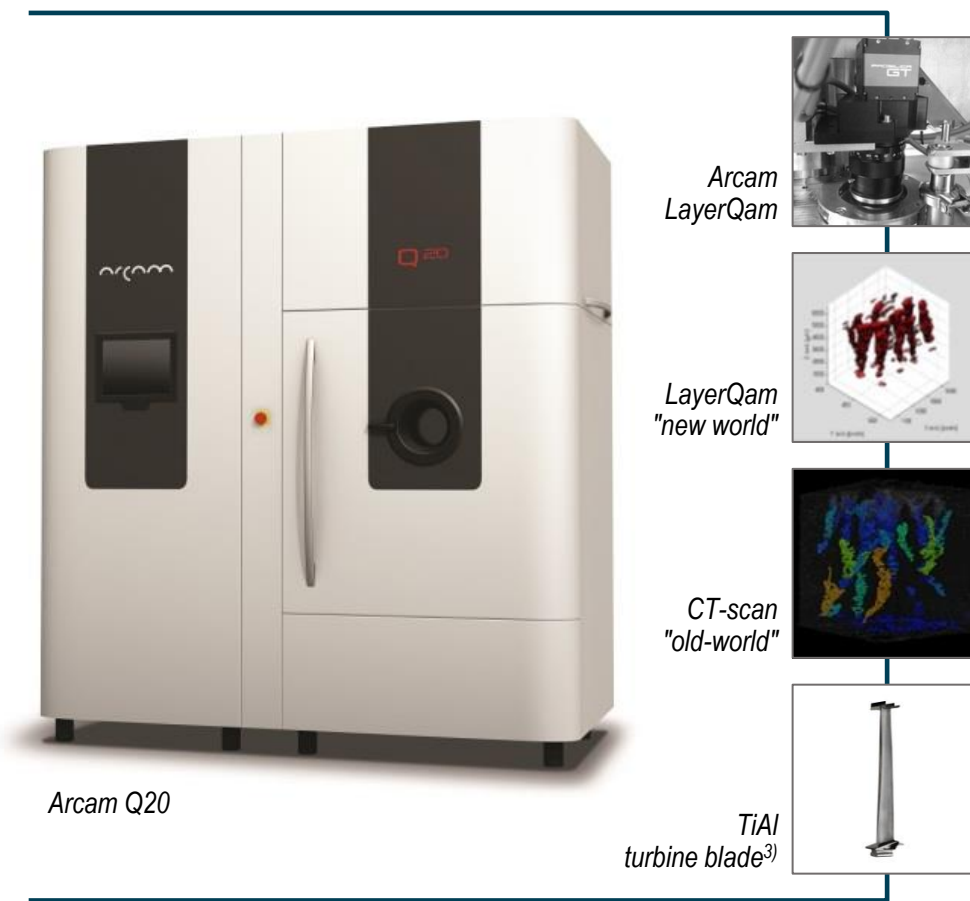

- > EB¹⁾ gun with up to 10 kW developed by Arcam, current 3 kW power output might be increased up to 5-6 kW as a first step
- > Key markets for EBM still in aerospace and implants
- > Key material still titanium – increasing demand for titanium aluminide (TiAl) and super alloys for applications in aerospace engines
- > Arcam still unchallenged, single supplier of PBF²⁾ EBM machines
- > Arcam machines can be integrated into production cell concepts by 3rd party integrators as part of a digital factory
- > The Arcam LayerQam takes CCD pictures of each layer for quality control – pictures left show (deliberate) porosities detected by Arcam LayerQam compared with a computer tomography (CT) scan.

1) Electron Beam 2) Powder Bed Fusion 3) Courtesy of Avio Aero

Automated unloading units increase machine productivity and further reduce labor cost in production

Automation concept

Manual unloading

- > The employee removes the build chamber after the end of the AM process and prepares the next build
- > While the machine is running again, the employee vacuums off the powder and removes the part
- > The build plate is replaced and the build chamber prepared for the next build run

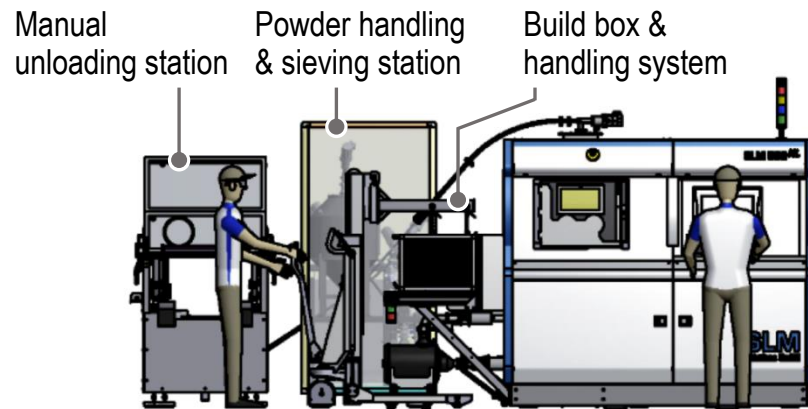

Typical AM system setup

Automated unloading

Concept

- > The employee is only needed to set up the build run and to monitor the process – the unloading of the part is completely automated
- > The build chamber is automatically turned and emptied during the unloading procedure



Automation concept study for AM system

Modularization concept by EOS is based on standalone peripherals that can be combined as needed

Modularization concept

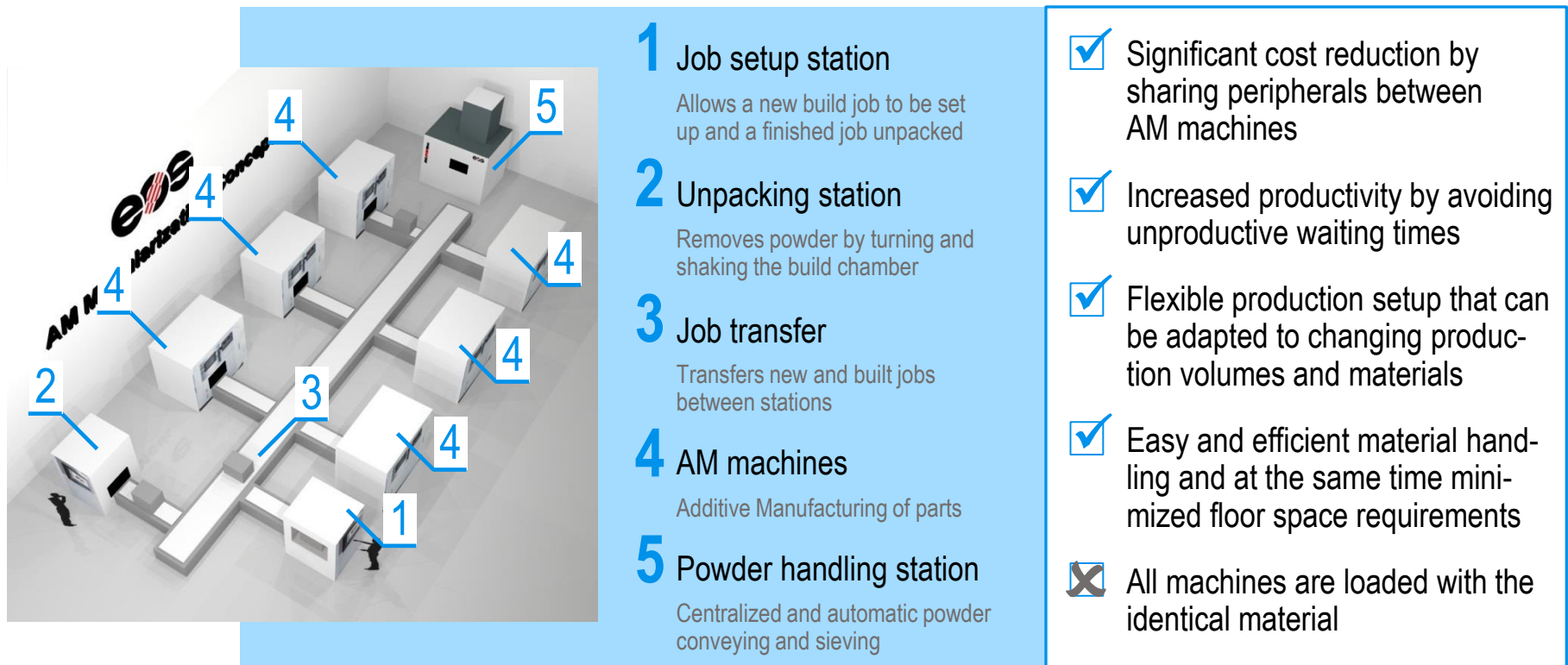

Modularization concept comprising several AM systems and peripherals (Source: EOS)

Next step is the integration of the Additive Manufacturing process into one modular machine – Additive Industries is the first mover

Integration concept

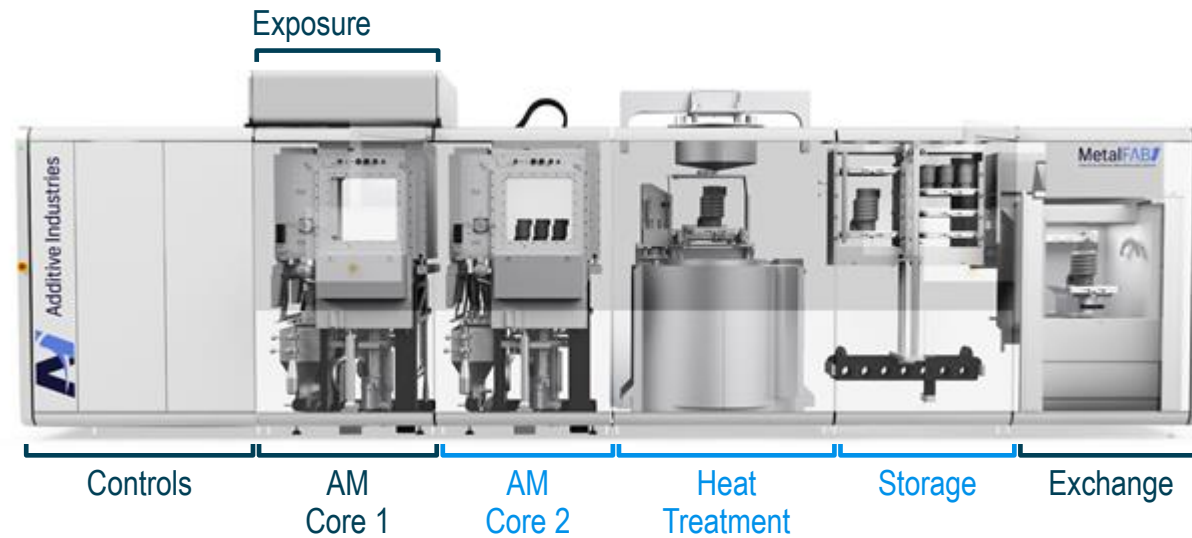

- > Multiple (1-4) full field laser and optics positions preventing the need for stitching
- > Effective build volume: 420x420x400 mm³
- > Strong reproducibility caused by robust thermal machine design and smart calibration strategies
- > Integrated post processing (heat treatment) increases process predictability and product quality
- > High productivity by continuous production (2 build chambers)
- > Instant switching between multiple materials gives a high flexibility
- > Automated handling by integrated robot, enclosure design and filter solution results in high operator safety
- > >112 h unmanned multi-job operation prevents multiple shift operations

MetalFAB1 Basic
(3 modules)

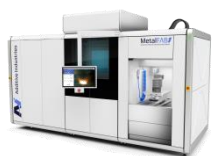

MetalFAB1 Productivity
(6 modules)

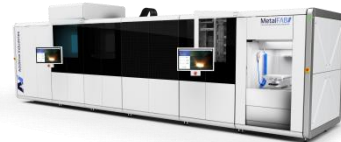

MetalFAB1 Max (11 modules)

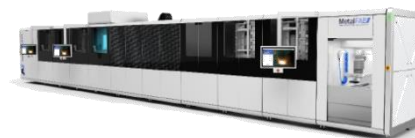

Modular scalable design allows for expansion of capacity, functionality and number of materials



Materialise offers software-embedded hardware to take control of laser-based AM systems

Materialise Controller for powder (metal/plastic) and resin bed

Conventional AM Control System

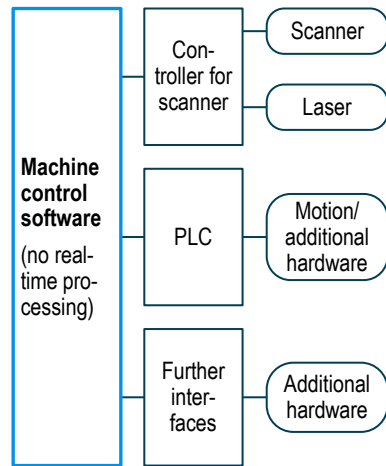

Materialise Controller

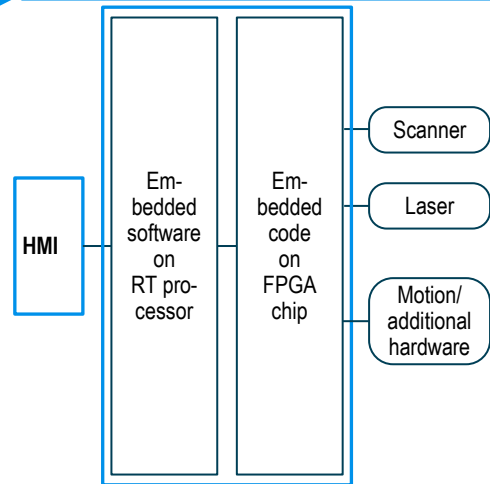

System description

- > Compared to conventional control systems, the Materialise Controller (a.k.a. AMCP) offers a modular, software-driven, embedded hardware solution with the following advantages: An FPGA system with real-time processing capability for improved process control allowing simultaneous data analysis and online control, easy and flexible integration of additional hardware and an open system architecture through use of standard protocols
- > Further modules are available that can be docked to the AMCP, like Human Machine Interface (HMI), Build Processor (BP), Heat Control Unit (HCU) or Vision in Loop (ViL)
- > The AMCP is engineered toward: (1) R&D applications that want to examine the AM process and benefit from real-time closed loop data processing, (2) Machine manufacturers who want to accelerate the development process and go fast to market building on Materialise knowledge, (3) Process controlled production applications to monitor and store all machine data and connect the machine using standard protocols
- > Materialise is already a leading supplier for AM software (Magics/Streamics) and is extending its offering toward machine control systems with the Materialise Controller

Printer System



Materialise Controller



The two Augsburg-based companies ExOne and Voxeljet specialize in binder jetting of silica sand, PMMA and metal

Binder jetting technology and examples

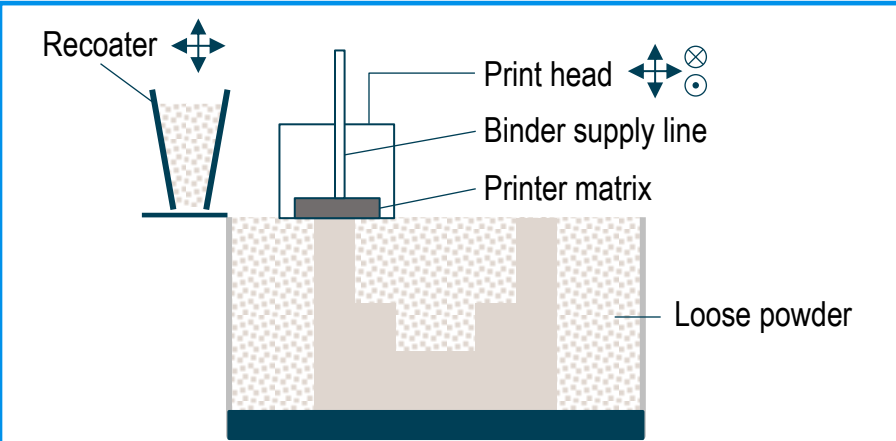

The diagram illustrates the binder jetting process. A recoater on the left spreads a layer of loose powder. A print head on the right, connected to a binder supply line, deposits binder onto the powder. The binder binds the powder particles together, forming a solid layer on top of the loose powder. The printer matrix is shown below the powder layer.

Working principle



*Printer VX 4000
(Source: Voxeljet)*



*Core step booster pump
(Source: ExOne)*

Working principle

- > Binder jetting allows the direct and indirect production of metal components
 - Direct production: Binder is injected into the metal powder. In a second process step the parts are sintered and sometimes infiltrated with a second metal. High densities are achieved by Hot Isostatic Pressing (HIP), typical material combination is stainless steel infiltrated with bronze
 - Indirect production: Casting forms and cores are printed by injecting binder into the silica sand or investment castings are printed by injecting binder into PMMA material followed by wax infiltration.
- A variety of material/binder systems are available, e.g. various sands from natural and artificial sources with organic and inorganic binders, PMMA with polymeric binders, etc.
- > The technology allows the direct production of complex geometries and offers cost efficient production of cores and castings forms via 3D printing
- > Compared to PBF by laser, binder jetting printers for silica sand can be very large, up to 4m x 2m x 1m operating at a speed of up to 400 l/h. Sand that is not part of the printed part needs to be removed before unloading the parts. Unused sand can be recycled and reused

ExOne has developed a fully automatic production line for silica sand cores using soluble glass as binder

Full line concept for serial production by ExOne

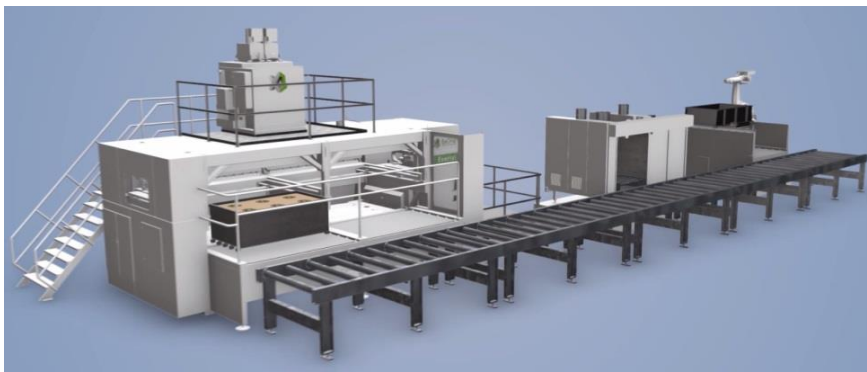

Production line concept (3D simulation)

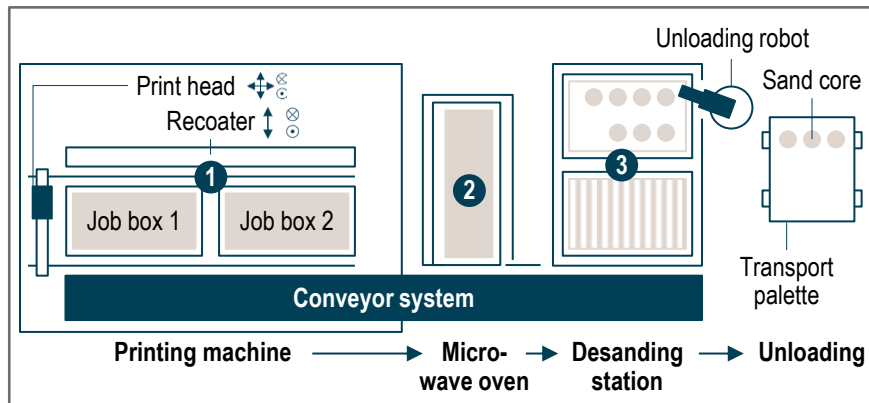

Process flow and machine setup

Working principle

- > The new machine concept by ExOne addresses the cost effective production of silica sand cores, which are difficult or impossible to manufacture by alternative processes due to their geometric complexity
- > ExOne provides a full line concept for serial production including one or more Exerial 3D printers (1), a curing and drying microwave station (2) and a desanding station with an unloading robot (3). The printer is equipped with two job boxes (2,200 x 1,200 x 700 mm³), which are moved by a conveyor system from station to station. Multiple configurations of the different elements are possible
- > The drying and curing of the environmentally friendly soluble glass binder material takes place in a microwave furnace
- > The build speed is in the range of 300-400 l/h, max. resolution of 0.1 mm and layer thicknesses from 0.28 to 0.5 mm
- > The current print head has a width of 600 mm, which means two runs to fully print the 1200 mm wide job box. A 1200 mm print head is expected to become available in 2016, which would boost the efficiency of the overall system close to the cost level of conventional automotive serial production

For high volume production of foundry sand cores, a continuous production technology is available from Voxeljet

Continuous production by binder jetting on a Voxeljet VXC 800



VXC 800 machine

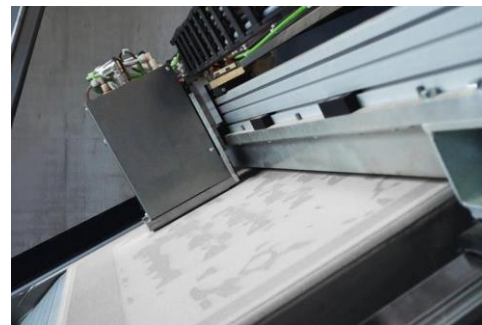

Print head on the tilted plain

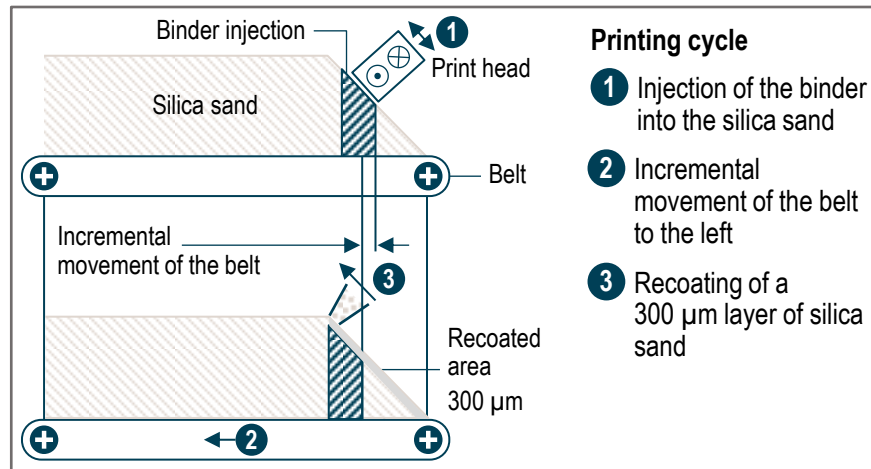

Working principle

- > The recoater forms a tilted plain out of foundry sand at approx. 45°. Binder is injected into the material by a 600 dpi print head moving over the tilted plain. After finalization the complete block of material is horizontally moved to the left allowing for the next production cycle. This way, continuous production is possible and the parts are removed from the belt while the machine is printing.
- > Build space of the machine is 850 mm x 500 mm x 1,500/2,000 mm with a layer thickness of 300 µm at a build speed of approx. 18l/h. Material system is silica sand with an inorganic binder
- > Voxeljet is planning to automate the unloading process as well in order to increase the total system output and automation level
- > Currently only a small number of machines in the market
- > This technology enables continuous production based on binder jetting technology and sand as powder. Theoretically this working principle could be transferred to powder bed fusion by laser or EB with metal powders

Next generation process control systems promise reduced need for downstream quality assurance, lower cost and higher part quality

AM process control – Process parameters, sources of irregularities and future solutions

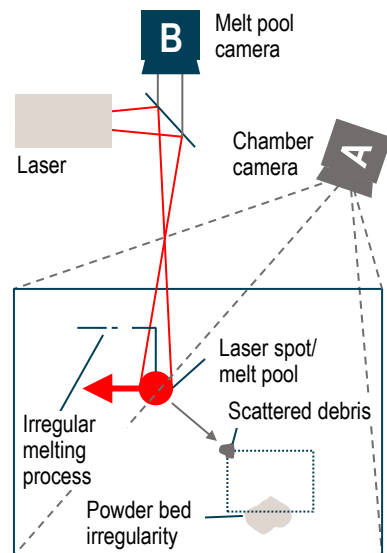



Illustration of the manufacturing chamber using two different process control systems (A,B); Final part quality is defined by various process parameters¹⁾, such as: laser characteristics (e.g. intensity and shape), melt pool characteristics (e.g. temperature, shape), chamber atmosphere (e.g. pressure), powder characteristics (e.g. even powder distribution, quality), etc.

 Final part geometry

Manufacturing quality is defined by different process parameters corresponding e.g. to the physical characteristics of the laser, melt pool, powder and chamber atmosphere¹⁾

Solutions for process control:

A Chamber process control

- > **Monitors the manufacturing chamber for irregularities on a layer-by-layer basis**
- > Monitoring system **documents and identifies deviation**, e.g. powder bed irregularities, scattered debris, incorrectly molten powder, fluctuating laser intensity, fluctuating atmosphere

B Melt pool process control

- > **Monitors the melting and exposure process in real time and checks for deviations** of relevant process parameters, e.g. melt pool temperature or shape
- > Due to the physical characteristics of the melting process requiring high-speed, high-resolution sensors, **melt pool process control is in the research stage** and subject to **limited commercial availability**

Advantages of process control :

- > **Reduced cost** – Real-time quality control reducing the need for downstream quality assurance
- > **Improved traceability** – Documentation of relevant parameters of the manufacturing process
- > **Higher quality and reliability** – Improved control over final part quality and increased process reliability
- > **Higher yield** – Early warning of process deviations and direct reaction

1) Identification of the correct set of process parameters for quality control represents an ongoing field of research

EOS' MeltPool module allows for real-time chamber and melt pool monitoring – Real-time control as a potential future step

Chamber and melt pool monitoring – EOS's EOSTATE MeltPool module



EOS M 290 AM system allowing for modular expansion with the EOSTATE MeltPool module

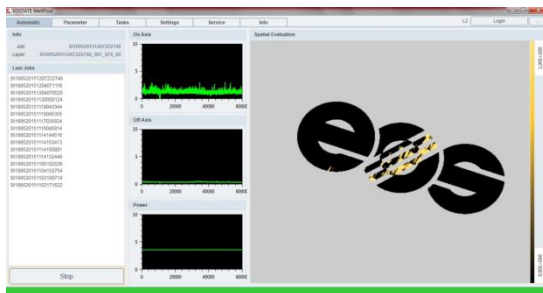

Screen view of the melt pool monitoring system for spatial evaluation of the manufacturing process

Process

- > **Two near-infrared photodiodes detect light emitted from the melt pool**
 - One **on-axis diode** within the optical system directly **monitors fluctuations of the melt pool itself**
 - One **off-axis diode monitors the complete manufacturing chamber**, e.g. to identify scattered side products
- > **Software algorithms** are applied, e.g. **to identify deviations** of the manufacturing process exceeding a predefined threshold **and for further visualization of the documented process** via reconstructed 3D images

Advantages

- > **Complete manufacturing and melting process documentation**
- > Reconstructed **3D image** for further **analysis of final part quality**
- > **Real-time detection of process deviations** on a layer-by-layer basis allowing for **reaction to potential errors** and implementation of counter measures, e.g. by pausing the process for inspection or skipping the erroneous part
- > **Cost advantage** due to reduced need for downstream quality assurance methods
- > Overall **increase in part quality and process reliability**



The system currently allows for real-time monitoring and documentation of the manuf. process – Active real-time control as potential future step

Process control over the melt pool dynamics – the heart of the manufacturing process – remains an ongoing field of research

Melt pool process control – ILT's spatially resolved high-speed pyrometry

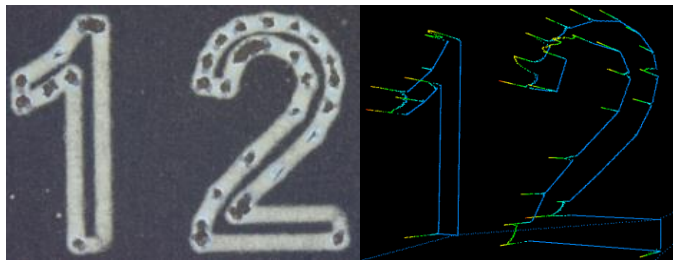

Image (left) and thermal image (right) of an anodized aluminum sample using ILT's high-speed pyrometry technology to reveal quality deviation in the manufacturing process

Process control

- > During manufacturing the **laser-heated powder** generates a melt pool, which **emits thermal radiation**
- > The emitted **radiation travels backwards** along the path of the laser beam **through the scanning system**
- > Within the optical system **thermal radiation is separated and detected by high-speed pyrometers** in real time during the AM process

Advantages

- > High-speed pyrometers (recording rates of 100 kHz) enable **real-time sampling on the relevant (short) time scales** even at high scanning speeds
- > **Spatial resolution is on the scale of the melt pool** (down to 20 μm)
- > **Monitoring and documentation** of the melt pool dynamics – the **heart of the manufacturing process** – approach the physically relevant scales

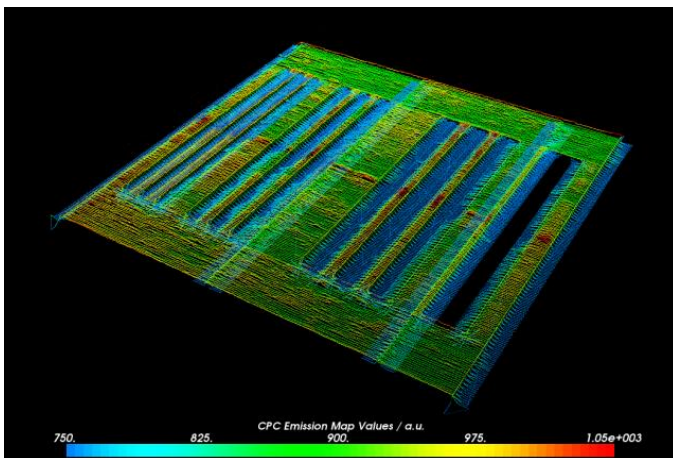

Mapping of the recorded thermal emission during the manufacturing process to XY coordinates enables documentation of the full manufacturing process



System **currently in research stage**; documentation and analysis of the melt pool as a **first step toward direct real-time control** of the heart of the manufacturing process

D. Post processing



Additive Manufacturing – next generation (AMnx) is characterized by innovations along the entire AM process chain

Next generation ...

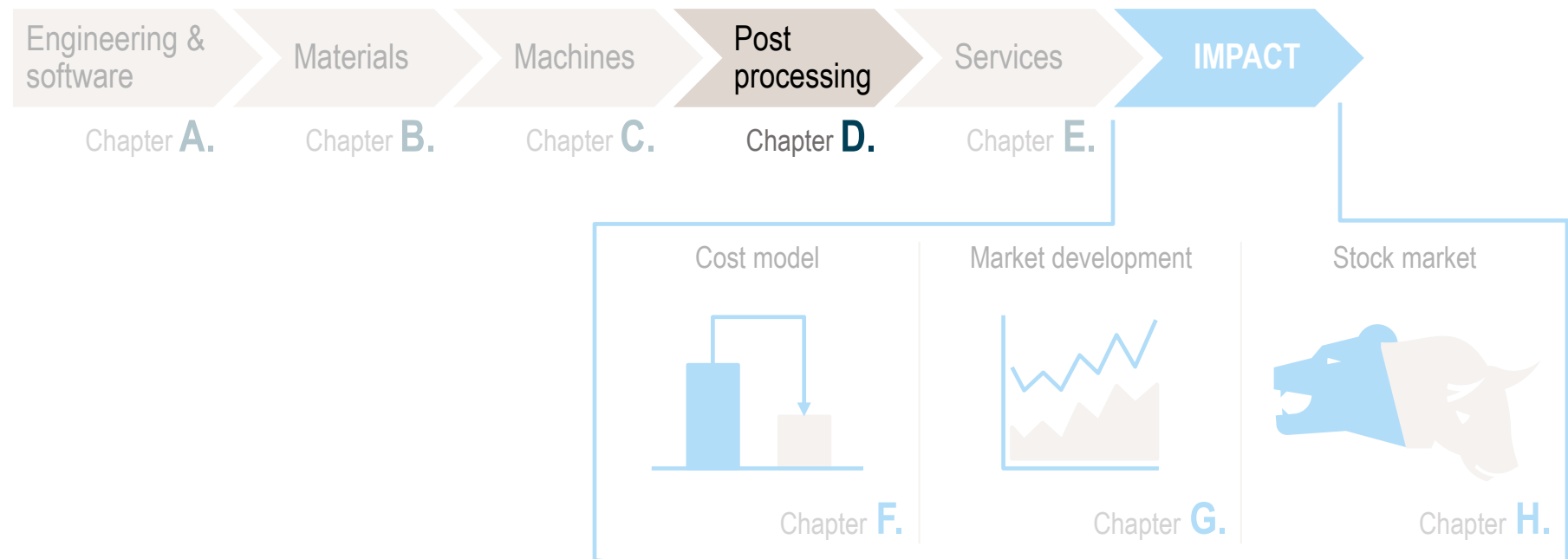

Additive Manufacturing does not produce final parts – Different degrees of post processing required to achieve target properties

Post processing of AM parts

> Parts do **not meet typical operating requirements** right after the AM process, especially regarding:

- Surface quality
- Geometrical tolerances
- Material properties



AM turbine blade, before and after surface treatment

> A **typical post processing chain** comprises the following elements – different combinations and orders may be required:

- 1 Sawing/EDM:** Separation of part from base plate, removal of support structures
- 2 Hot isostatic pressing:** Reduction of remaining porosity to improve fatigue resistance *and/or*
- 3 Heat treatment:** Mitigation of inner tensions, control of material properties
- 4 Machining:** Preparation of functional surfaces, compliance with geometrical tolerances
- 5 Surface treatment:** Fabrication of required surface quality and/or surface hardness
- 6 Quality inspection:** Control of dimensional accuracy, surface and material properties

> It is often possible to **reduce the post processing effort** by keeping the entire process in mind during the design stage

BinC Industries' MMP technology is a selective surface treatment that differs from conventional methods such as barrel finishing

Micro Machining Process (MMP) technology

MMP technology

- > **Surface treatment** for a **large range of materials**, including steel, copper, nickel, titanium, ceramics, plastics and coatings
- > **Roughness** is eliminated from smallest-scale roughness to waviness in **batch process with successive stages**
- > Parts are mounted on **custom-made, reusable fixtures** and dipped into a fluid with "microtools", which **selectively attack only a very specific range** of micro-roughness per stage
- > Microtools are chosen to specifically replicate a part's **roughness profile** at a certain level (e.g. secondary micro-roughness)
- > **3-axis movement** for relative motion between work piece and microtools avoids formation of a preferred direction
 - The actual removal process is **solely mechanical**
 - Once a targeted roughness level has been eliminated, no **further material** is being **removed** (high selectivity of microtools)

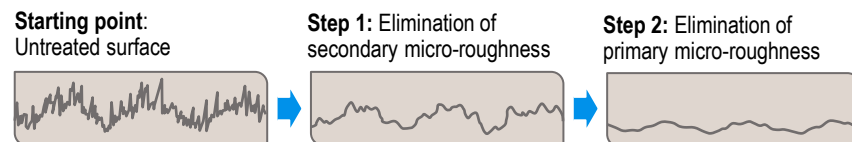

Multiple stage polishing process

Note: BinC Industries SA, focusing on industrial markets, was separated from luxury goods-oriented BESTinCLASS SA in 2014

Limitations

- > **Unfavorable** cost structure for **single piece production**
 - **Validation process** needs to be completed first (part analysis, selection of matching microtools and design of custom fixtures)
- > **Certain geometries** (e.g. deep drilling holes, U-shaped channels) are not suitable for this method
- > **Form errors** cannot be mitigated – only roughness and waviness
- > **Technology** details kept under **tight control** (IP protection)
- > Currently no **production site in Germany** (not before 2016)

Benefits

- > Relatively **minor material removal** realizable, dependent on production process and intended finishing
- > **Form preservation** – almost no rounding of edges or fine threads
- > High **process reproducibility**
- > **R_a values <0.015 μm** and a **mirror-like polish** can be achieved
- > **Costs are not a function of geometrical complexity**
- > **Fine control of surface roughness**, e.g. removal of only secondary micro-roughness (**mitigation of notch effects** from fine surface defects, **better adhesion** of coatings)

MMP is a suitable technology for finishing of AM parts, but the processing effort can be higher for AM than for machined parts

Micro Machining Process (MMP) technology

Applicability of MMP for AM parts

- > Surface quality of $R_a < 15 \mu\text{m}$ is a sufficient starting point
- > AM parts usually feature a **larger variety of surface roughness frequencies** than e.g. milled surfaces due to production process induced phenomena such as staircase errors
 - **Several MMP treatments** might be necessary to ensure complete "coverage" in light of microtools' high selectivity
- > **Up to 50 μm** of material need to be **removed from AM parts** to achieve a mirror polish, compared to only 5 to 20 μm of necessary material removal in case of machined parts
- > MMP is most suitable for **high-value parts** produced **in series**, which profit from precise form preservation
- > MMP can also be regarded as the ultima ratio **when traditional surface treatment methods are not applicable**, e.g. due to certain complex geometries

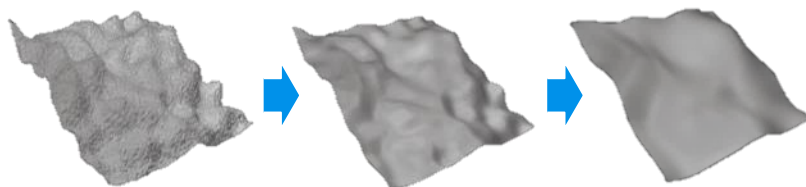

3D surface structure throughout different stages of the process

Background information

- > **BinC Industries** is a **Swiss-based company** founded in 1995
- > Manufactured parts can be treated at the **respective facilities of BinC Industries** or of its partners
- > In total, there are **seven locations** (wholly owned and joint ventures) worldwide, of which **four are production sites**
 - Plants in France, USA, India and China
- > **Machines can also be operated at the customers' plants** by BinC Industries and its partners as a shop-in-shop solution
- > **First Surface Germany** is a **joint venture** between BinC Industries and **EOS**, but according to the company, the business is run **independently** from the AM machines specialist



Fuel air swirler before and after MMP surface treatment

Computed tomography can be used to non-destructively detect even small material defects like porosity in AM parts

Computed tomography in quality inspection

Example: Werth TomoScope HV 500

- > Combination of coordinate measuring with computed tomography (CT)
- > Capturing of fine details, even porosity, for complex and inaccessible geometries is possible
- > CT resolution can be locally adjusted to scan regions of interest with higher precision, e.g. where melt pool monitoring system has detected potential flaws
 - This reduces both the amount of time needed and the amount of data produced per part for non-destructive porosity checks
- > Application-specific automation concepts with adjusted hardware and software are conceivable



Werth TomoScope HV 500

WinWerth software for data evaluation

- > Calculation of a 3D point cloud from measurement data
- > Analysis of dimensions and of geometrical tolerances
- > Automated comparison with CAD data
 - Optical highlighting of geometry deviations
- > **Tactile scan** of master part can be used to **automatically compensate for systematic CT artefacts** in case of series measurement
- > In addition to quality control, software can also be used for reverse engineering of parts

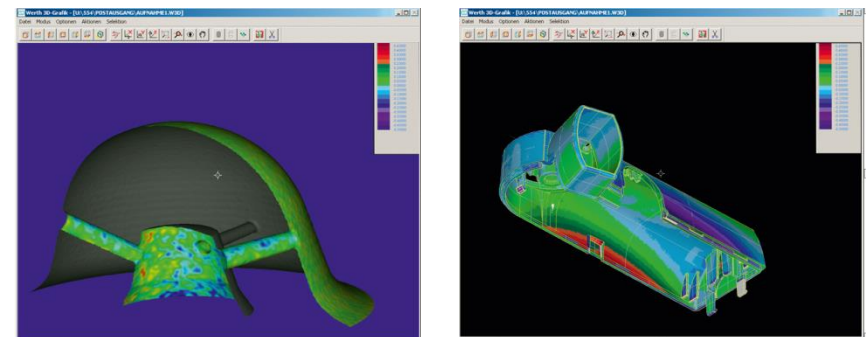

Highlighting of geometry deviations in WinWerth software

E. Services



Additive Manufacturing – next generation (AMnx) is characterized by innovations along the entire AM process chain

Next generation ...

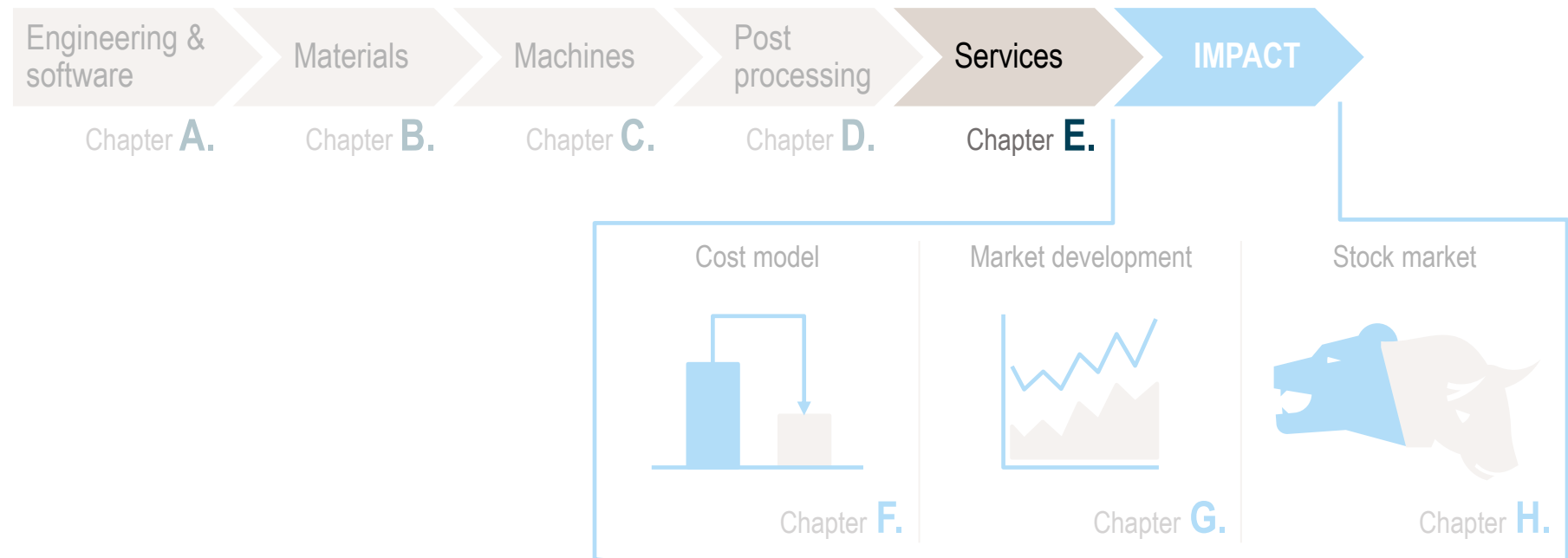

Additive Manufacturing offers new opportunities for the repair of complex and high-value components

Example: Gas burner tip repair



Repair process

- > Additive Manufacturing can be used for repair of complex and high-value components
- > For example, **Siemens** utilizes AM for the **repair of gas turbine burner tips**, which exhibit high levels of wear and tear after a certain operating time
- > Instead of replacing a large section of the burner with conventionally produced spare parts, only damaged material is milled off the burner tip
- > Afterwards, the burner is placed in an individually adapted EOSINT M 280 and restored via AM
 - Adjustments to the AM system include a new build chamber to accommodate the 800 mm burner as well as further hardware and software changes
- > The new repair process saves both material and time
- > Additionally, it is possible to upgrade the design of old burners

"Mobile" applications of AM on large container ships, aircraft carriers or for military vehicle repair are becoming more and more relevant

Example – AM for mobile repair services

Ongoing developments



- > Maersk ship line has installed plastic AM systems on some ships in their merchant vessel fleet



- > The US Navy has installed first plastic AM systems on combat ships like the aircraft carrier USS Essex, where it already produces e.g. simple spare parts



- > Mobile print centers in containers for ground troops are under investigation by several armies, e.g. US Army's containerized mobile Expeditionary Labs

Example: Fighter plane nose cone repair



Sketch of the actual (vertical) landing maneuver



3D printed tools and fighter plane nose cone

- > An AV-8B Harrier jet was **damaged during landing** after its nose gear failed to deploy – repair of the nose cone was required
- > **Plastic tools** needed for carrying out the repair were **produced via Additive Manufacturing** within 48h of receiving the part's original CAD models from the OEM

Outlook

- > So far, usually **relatively robust FDM printers** are used by maintenance staff for production of assembly tools, bending tools or relatively simple plastic replacement parts
- > The use of **metal AM** in mobile applications is more difficult due to its **sensitivity to vibrations**
- > In a next step, binder jetting could be utilized to create molds for producing metal parts
- > The **RepAir project** bundles repair activities for the aerospace industry

F. Cost model



Additive Manufacturing – next generation (AMnx) is characterized by innovations along the entire AM process chain

Next generation ...

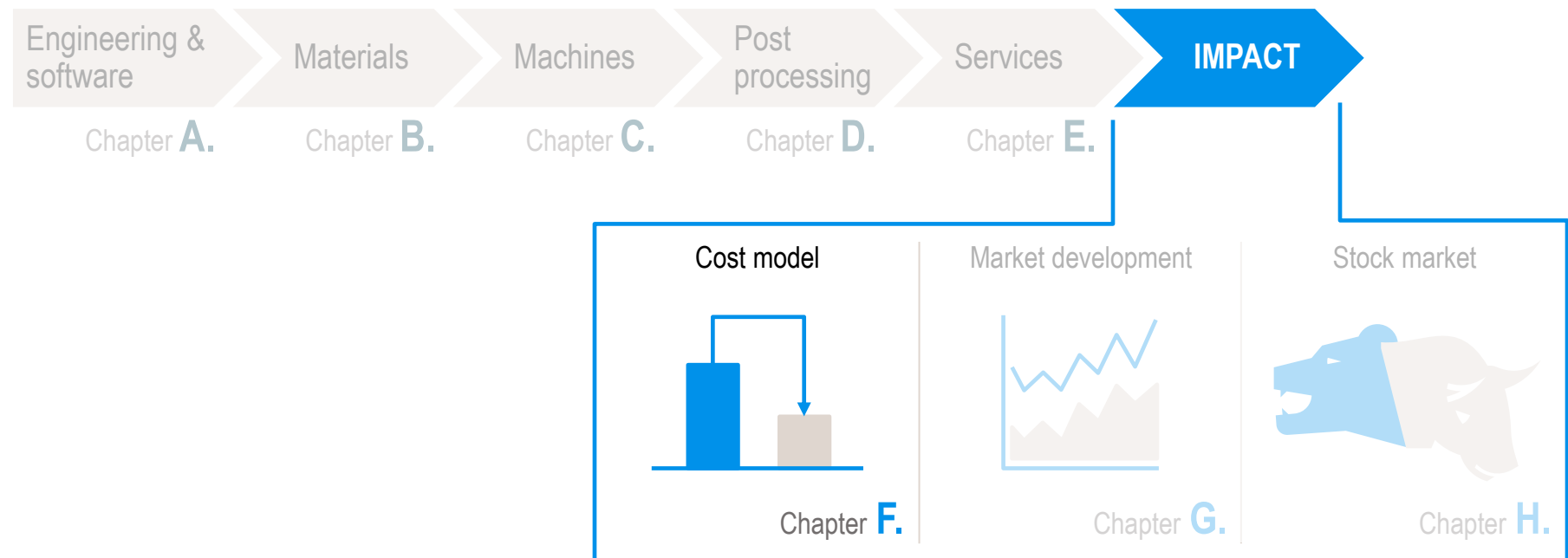

Three different AM system classes can be distinguished – From small single- or multi-laser machines to large machines

AM system classes

Small single-laser

- > System class with **lowest investment cost**
- > **Lower productivity** counter-weighs low system price

Sample machines¹⁾



Sample configuration

Investment cost: EUR > 0.5 m²
 Build rate (IN718): 10-15 cm³/h
 Build chamber: 250x250x300 - 280x280x350 mm

Small multi-laser

- > **High productivity** due to 2 lasers at still **moderate price**
- > Well suited to **serial production of smaller parts**

Sample machines¹⁾



Sample configuration

Investment cost: EUR 0.5-1 m²
 Build rate (IN718): 20-25 cm³/h
 Build chamber: 250x250x300 - 280x280x350 mm

Large machines

- > **Highest productivity** when utilizing up to 4 lasers
- > Allows production of **greater parts or larger batch sizes**
- > **Automation** concepts available

Sample machines¹⁾

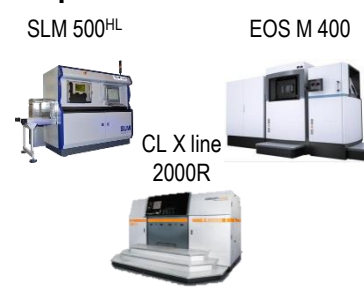

Sample configuration

Investment cost: EUR > 1 m²
 Build rate (IN718): 40-45 cm³/h
 Build chamber: 500x280x325 - 800x400x500 mm

- > Different **AM system classes** are available on the market, targeting specific customer needs and use cases
- > Choice of best-suited machine depends on **actual usage conditions** and is a trade-off between investment cost, production cost and system capabilities

1) Non-exhaustive list of sample machines according to generic AM system classification – suitability of each machine needs to be determined based on individual usage conditions

2) Including supplementary equipment

Hourly machine rates for all classes were calculated based on a standardized routine – Figures differ by more than a factor of 2

Hourly machine rates (2016) [EUR/h]

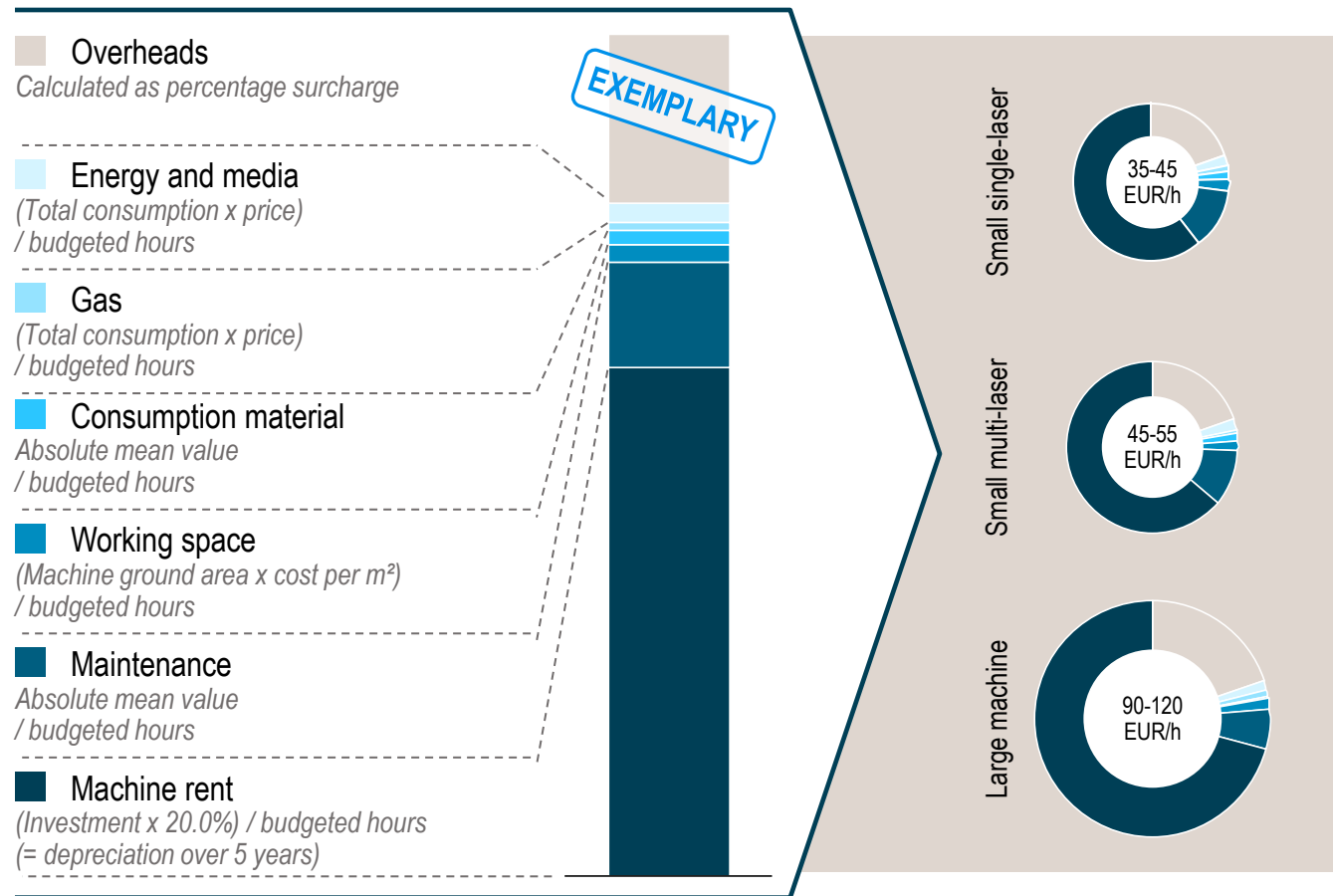

Assumptions

- > 5-year depreciation period
- > 2.5 shift model (5,000 h p.a.)
- > 10% maintenance and downtime (4,500 h p.a. remaining)
- > Material and direct labor are not included in hourly machine rates

Multi-laser machines offer a cost advantage in the production process despite their higher hourly machine rates

AM cost by system class (material: Inconel 718) [EUR cent/g]

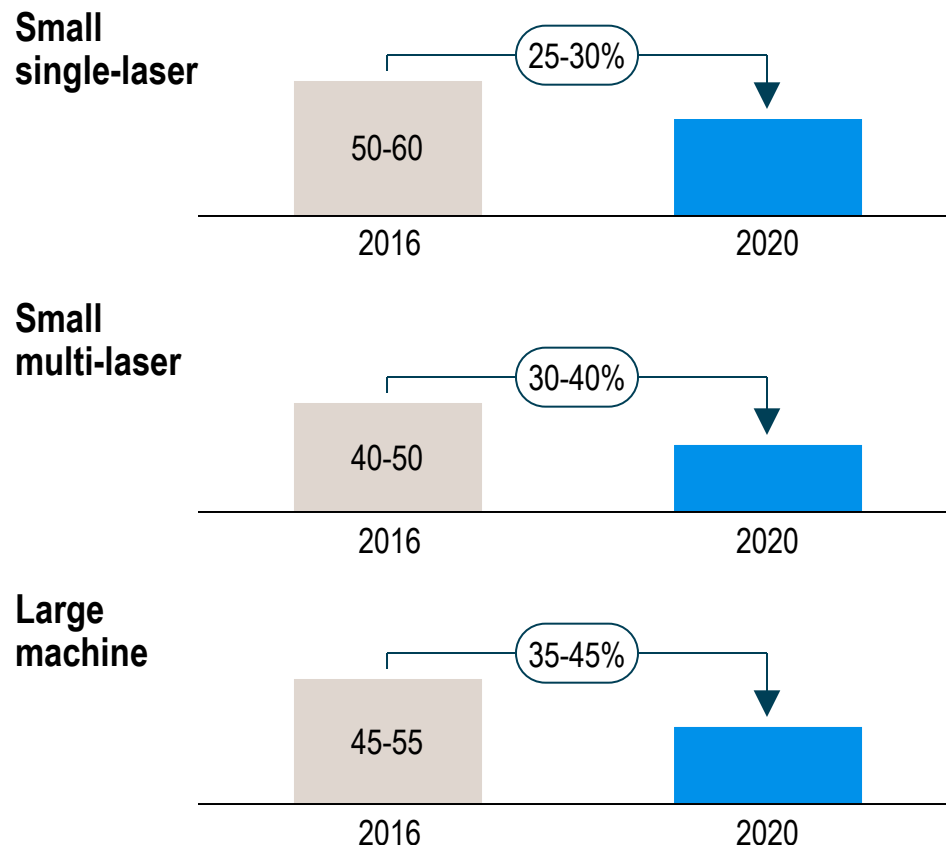

- > AM costs include AM system, labor and material costs
 - Direct **labor costs** on average constitute less than 10% of AM cost
- > **Small multi-laser and large machines** produce parts approx. **20% cheaper** than small single-laser machines when utilized efficiently
- > Further **AM cost reduction** of approx. **25-45%** until 2020 expected, driven by e.g. improved **overlap capabilities** for multi-laser machines, increased laser power, optimization of **powder dispensing process** and **increased layer thickness** at constant quality
 - **Multi-laser process** with **higher potential** for performance improvement at same hardware cost
 - **No technological step changes** in AM process **assumed** for this evaluation

AM costs vary depending on powder material – Driven by different powder prices but also by different achievable build rates

AM cost by material (small multi-laser machine) [EUR/g and EUR/cm³]

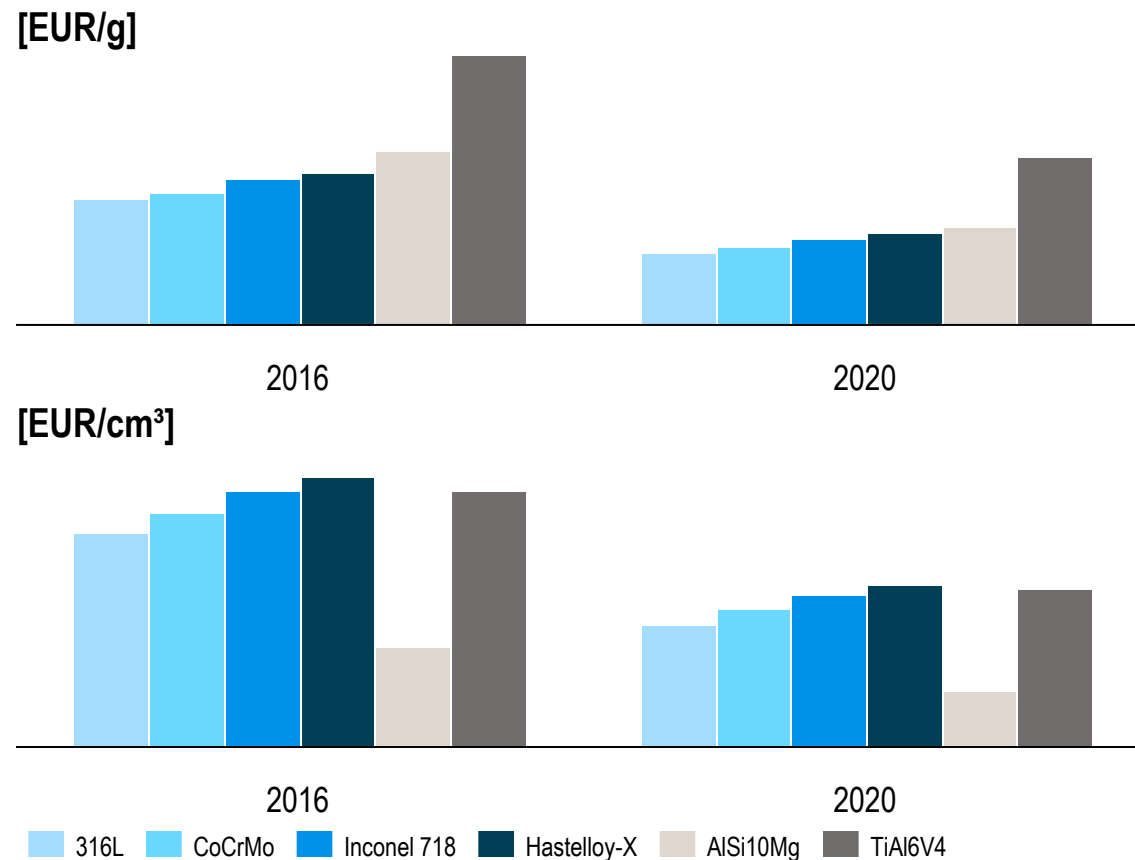

- > Due to **low deviations in build rates and material densities**, price differences between 316L, CoCrMo, Inconel 718 and Hastelloy-X are largely **driven by metal powder prices**
- > **TiAl6V4** is by far the **most expensive metal powder** but has a lower density and can be processed at **high volumetric build rates**, which dampens the effect on AM cost per cm³
- > Low density of **AlSi10Mg** leads to very low AM cost per cm³

While metal powder prices vary greatly by material, significant cost savings can be achieved by sourcing from independent suppliers

Metal powder prices [EUR/kg]

Indicative

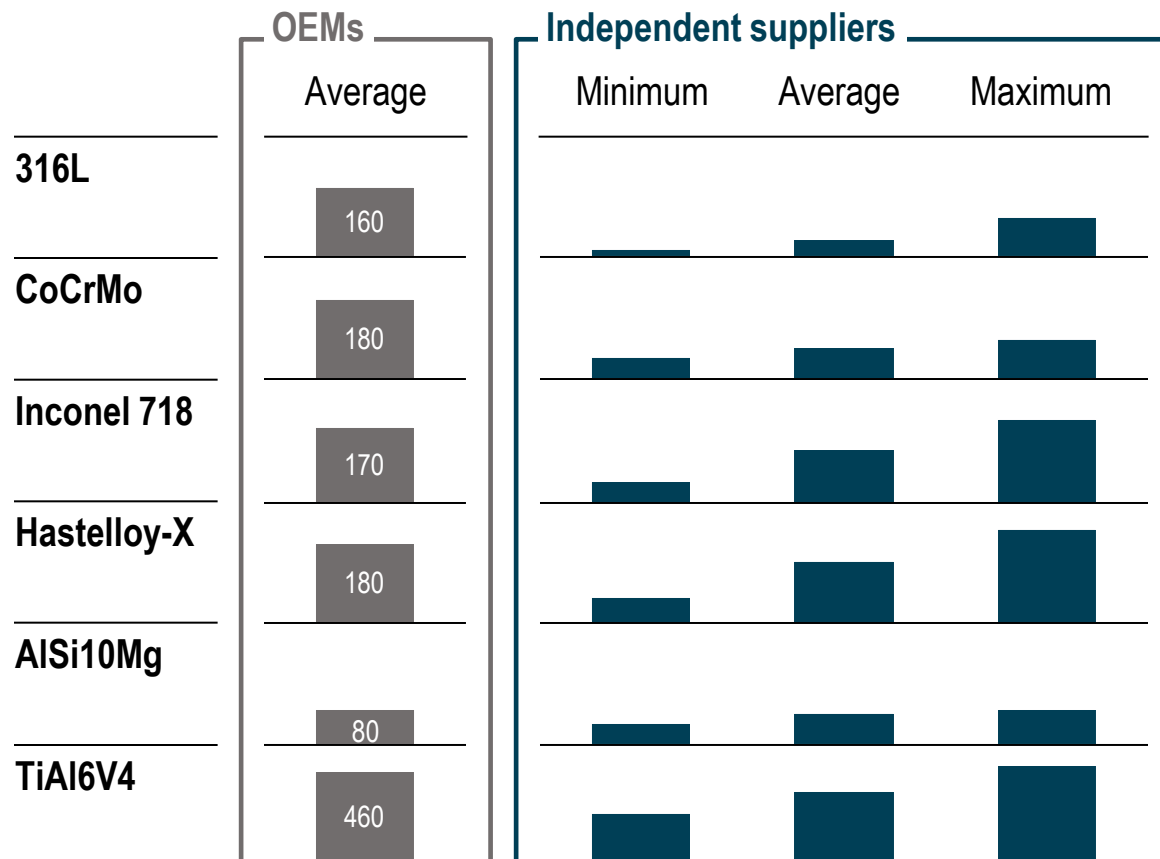

- > A large variance in powder prices per material can be observed between different suppliers
- > Independent suppliers often offer materials suitable for Additive Manufacturing at much lower cost than OEMs
 - Distributors, large producers as well as small specialist players were included in the analysis
- > OEMs offer the advantage of being able to provide their clients with material-specific parameter sets and further powder quality control
- > Companies need to weigh initial implementation speed and reliability against the resulting higher cost and lock-in effect

Note: Metal powder prices depend greatly on specification of demanded properties, production process (e.g. VIM) and batch sizes – figures on this slide are indicative only

The role of post processing costs should not be underestimated when assessing a component's suitability for AM serial production

Total production cost breakdown

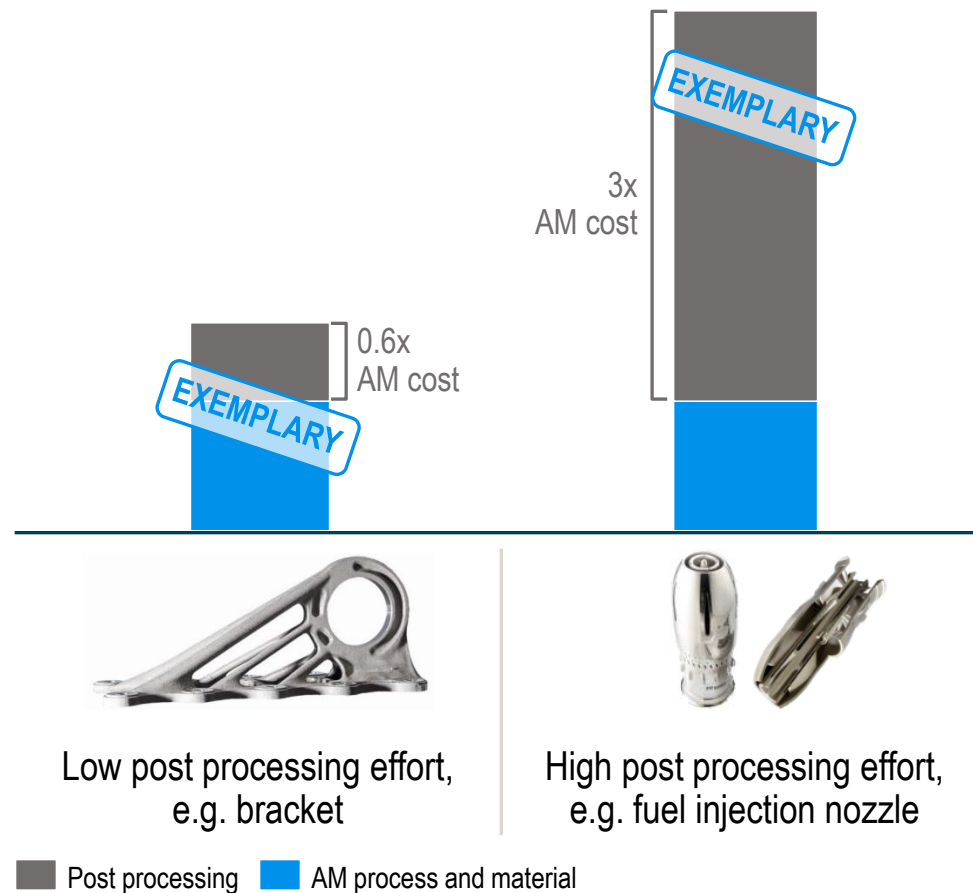

- > **Virtually all AM components** require post processing, such as sawing/EDM from base plate, removal of support structures and some form of surface treatment, e.g. shot peening
- > **Further post processing steps** typically comprise heat treatment and/or HIP, machining of functional surfaces, different surface treatments and quality inspection
- > Even when post processing costs are high, **AM can still be the most cost efficient option** when even more complex conventional production processes and tools can be replaced
- > The required amount and order of post processing is **highly part-individual** and cannot be estimated with multiples
- > The **required manufacturing process** should be established jointly with production planning and used as a basis for the calculation of total cost

G. Market development



Additive Manufacturing – next generation (AMnx) is characterized by innovations along the entire AM process chain

Next generation ...

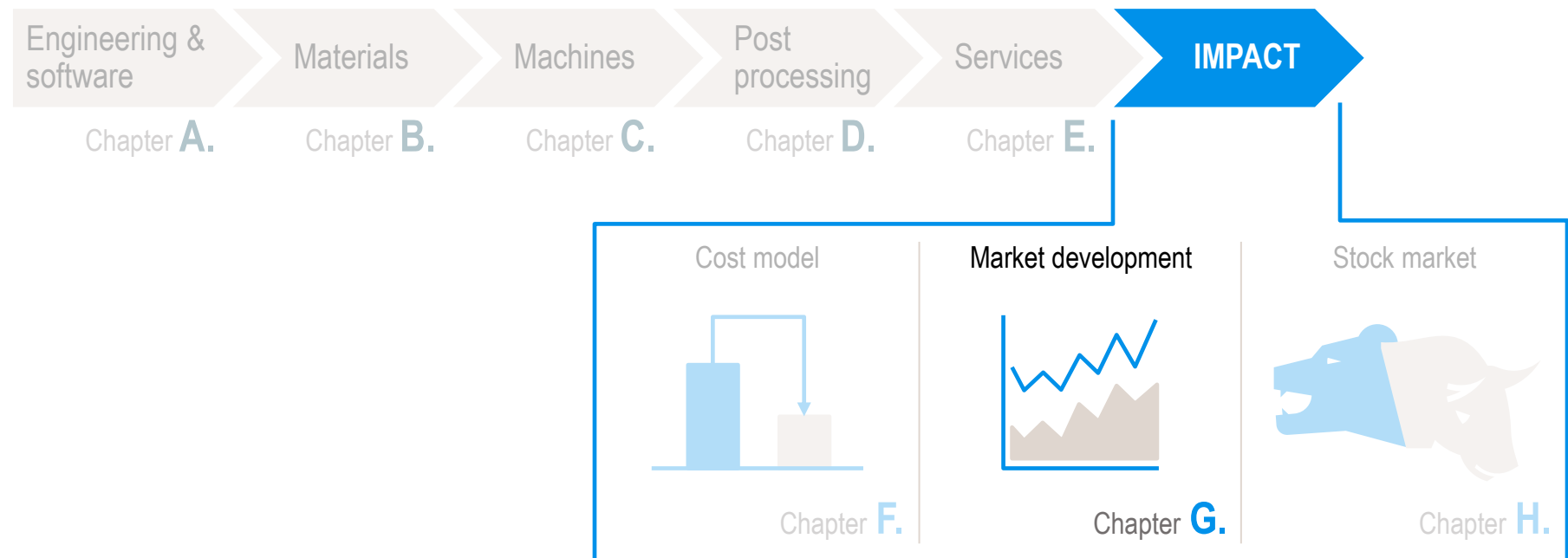

Global AM market is expected to grow significantly until 2020 – Growth rates of up to 40% per year expected by researchers

Global AM market

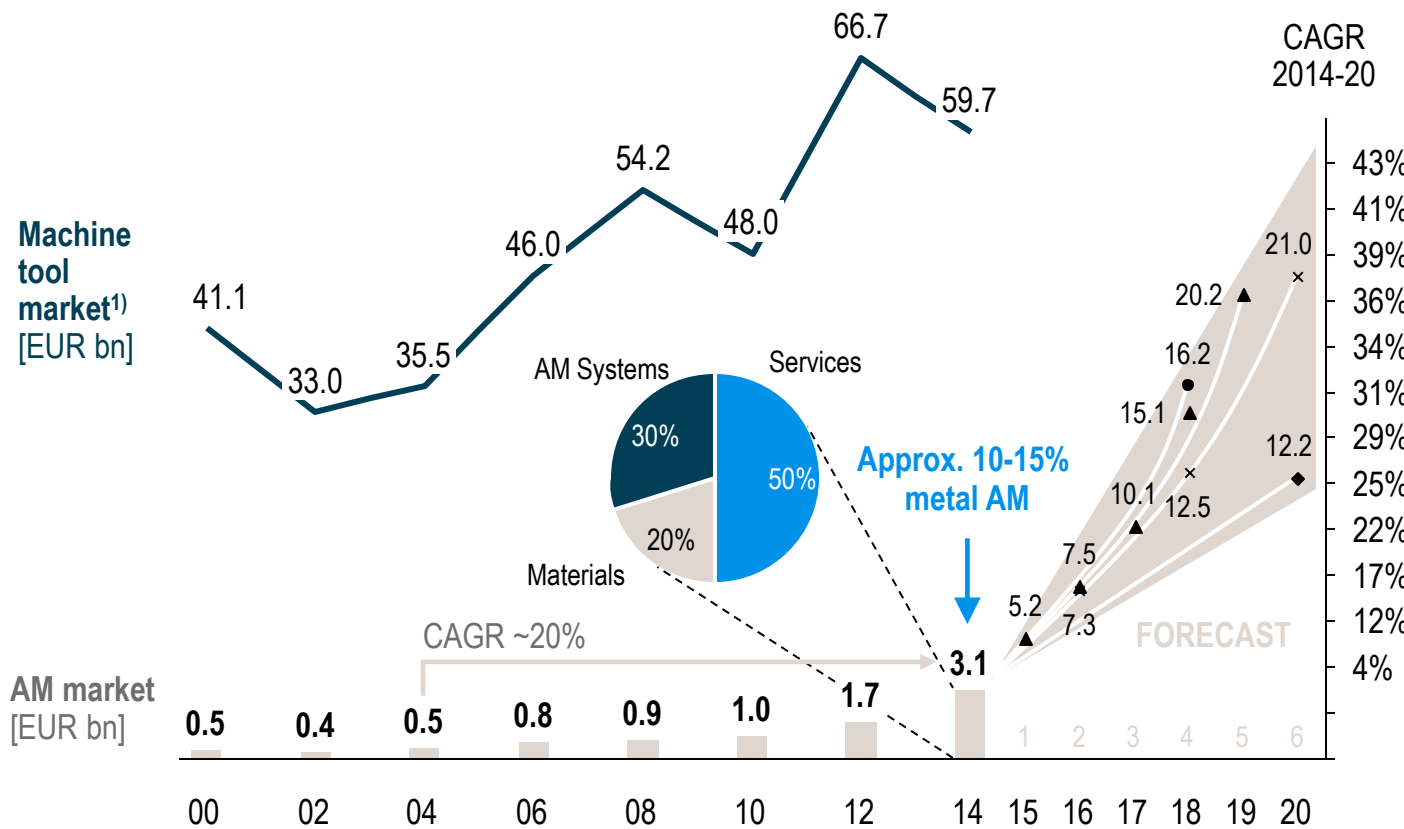

- > Compared to the machine tool market, the 2014 metal AM system market is still small at less than 1%
- > For the period 2004 to 2014, the overall AM market showed an annual growth rate (CAGR) of approx. 20%, while from 2010 to 2014 the growth rate (CAGR) was higher than 30%
- > Based on different, actual estimates the **market is expected to multiply** by factor two to seven until 2020

1) World production excl. parts/accessories
 × Wohlers Associates ◆ MarketsAndMarkets
 ● Bloomberg Business Week ▲ Canals

Up to 2014, German manufacturers provided almost 70% of the 1,601 metal AM systems (PBF) sold worldwide

Cumulative market share of metal AM system (PBF) manufacturers

Metal AM systems (PBF) sold up to 2014

1,601 metal AM systems (PBF)

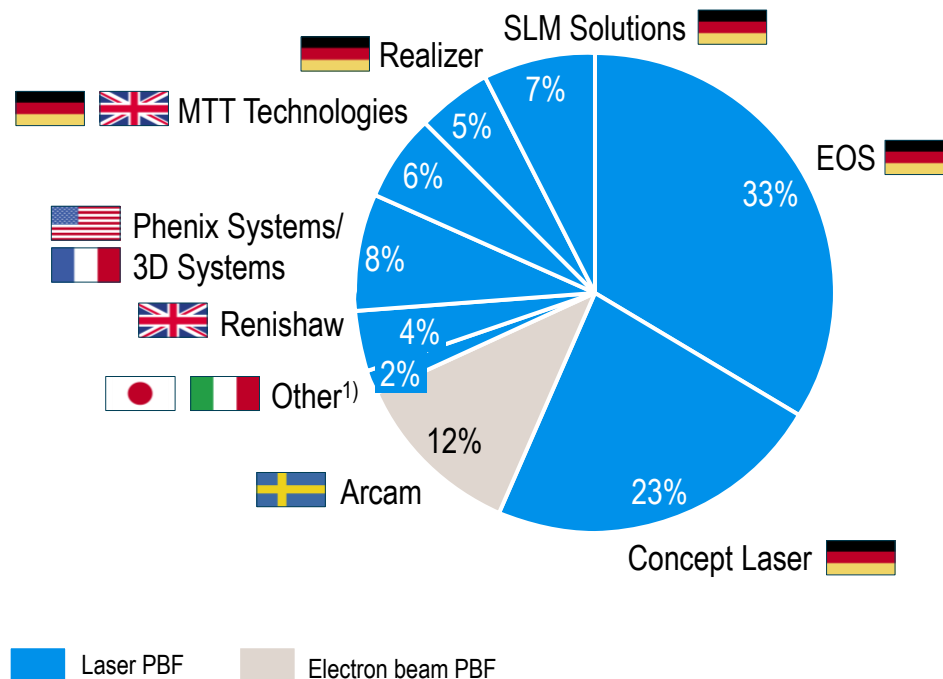

1) Other laser PBF sales: Matsuura (JPN), OPM Lab (JPN), Sisma (ITA)

Beyond the figures

- > **MTT Technologies:** No longer active. Company was split up in 2010 into SLM Solutions and MTT Technology Ltd. (which now belongs to Renishaw)
- > **Phenix Systems:** Company was sold to 3D Systems in 2013
- > **New players** recently entered the segment, e.g. Additive Industries, Matsuura or OPM Lab
- > Binder jetting and directed energy deposition not included in this analysis

H. Stock market



Additive Manufacturing – next generation (AMnx) is characterized by innovations along the entire AM process chain

Next generation ...

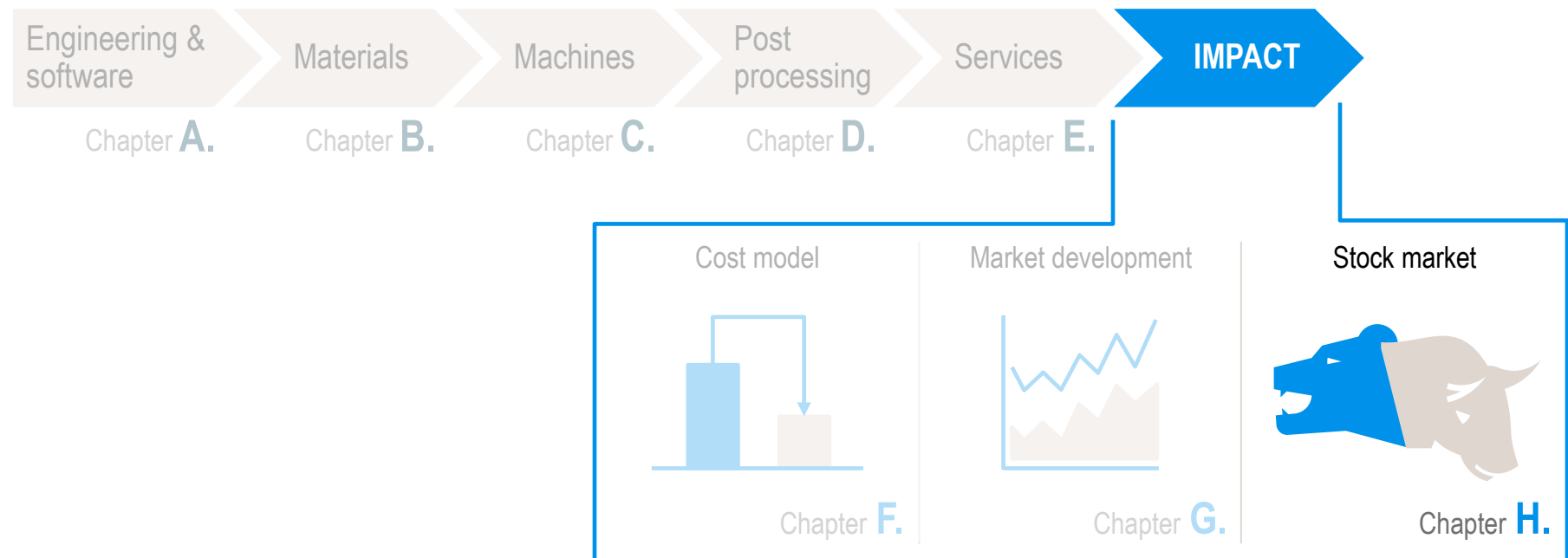

The first printed gun and the ensuing stock rally led to a media hype about Additive Manufacturing in 2013 and 2014

Key events in 3D printing

Google searches for "3D printing"¹⁾

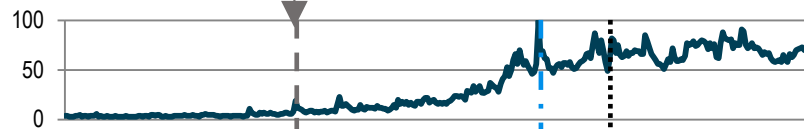

First major announcement of Additive Manufacturing

> GE starts industrial use of AM for its jet engines



Stock of Arcam AB [USD]



Biggest hype

> 1st 3D printed gun is unveiled (May 3, 2013)
> News media all around the world start covering the 3D printing industry



Stock of Voxeljet AG [USD]



Highest stock valuation

> IPO of the small German 3D printing company Voxeljet AG
> Stock prices reach all-time high after five-month rally



Stock of 3D Systems, Inc. [USD]

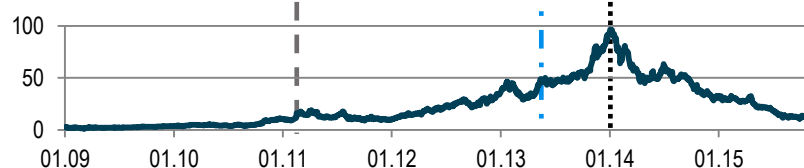

1) Highest search volume = 100 points

Stock indices representing the AM industry peaked at the maximum of the media hype around the end of 2013 but declined ever since

3D printing industry tracker

Bloomberg World Machinery Index¹⁾

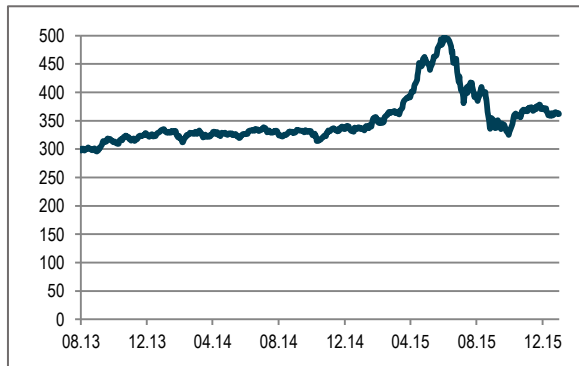

Scope of represented industries

- > Leading machinery-diversified stocks in the world

Solactive 3D Printing Index²⁾



- > Tracks companies that invest or plan to invest at least 1% of revenue in 3D printing industry (hardware + software)
- > Includes, among others, 3D Systems, Arcam, Autodesk, ExOne, Materialise, Organovo Holdings, Proto Labs, SLM Solutions, Stratasys and Voxeljet

STOXX Global 3D Printing Pure Play³⁾



Focus on 3D printing

- > Tracks companies that generate at least 10% of revenue in the 3D printing industry
- > Includes, among others, 3D Systems, 3Dfamily Technology, Alphaform, Arcam, Arrk, ExOne, Perceptron and Stratasys

1) Index is capitalization weighted in USD 2) Index is calculated as a total return index in USD 3) Index is free float market capitalization weighted in USD

Although stock prices of established AM companies declined, analyst grades indicate hold or buy positions

Stock prices [USD]

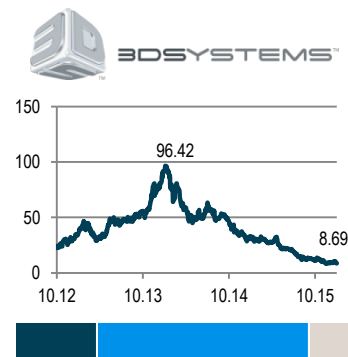

- > IPO: 1989
- > Focus on PBF (plastic)
- > Daily trading volume approx. 3.7 m stocks, tending downward
- > 3D Systems is the AM pioneer – first system sold in 1988
- > 49 acquisitions since 2009; cumulative acquisitions in 2014 total USD 345 m

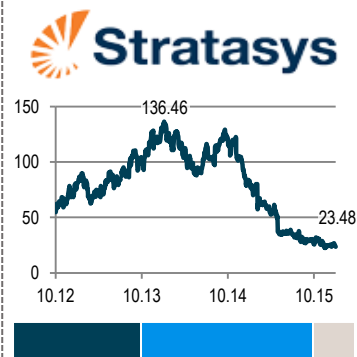

- > IPO: 1994
- > Focus on material extrusion
- > Daily trading volume approx. 1.1 m stocks, tending upward
- > Acquisition of MakerBot (2013) and several service providers (2014)
- > New technology enables jetting of three different base materials

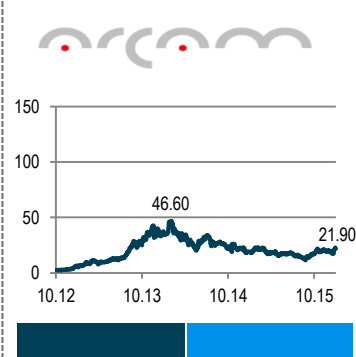

- > IPO: 2000
- > Focus on PBF by electron beam
- > Daily trading volume approx. 126 k stocks, tending downward
- > Inventor of PBF by electron beam
- > Expanded into powder materials and services
- > 2 acquisitions in 2014 for USD 47 m

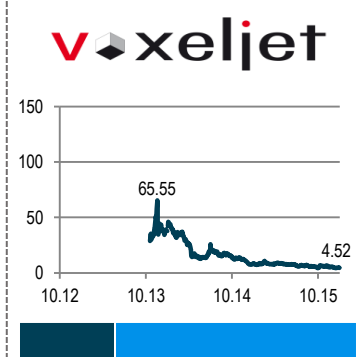

- > IPO: 2013
- > Focus on binder jetting
- > Daily trading volume approx. 3.1 k stocks, tending downward
- > Developed new phenolic binder in 2014 enabling higher resolution, precision and powder recyclability rate
- > Opened new service facility in the US in 2015

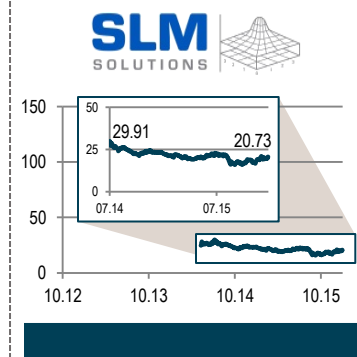

- > IPO: 2014
- > Focus on PBF by laser (metal)
- > Daily trading volume approx. 31 k stocks, tending upward
- > Versatile systems due to open system architecture – most metal powders applicable

Analyst grades distribution: Buy Hold Sell

Overvalued AM stocks are approaching fair valuation – Stock profits are likely to be appropriate and stable in the medium term

Price/earnings ratios of listed AM suppliers

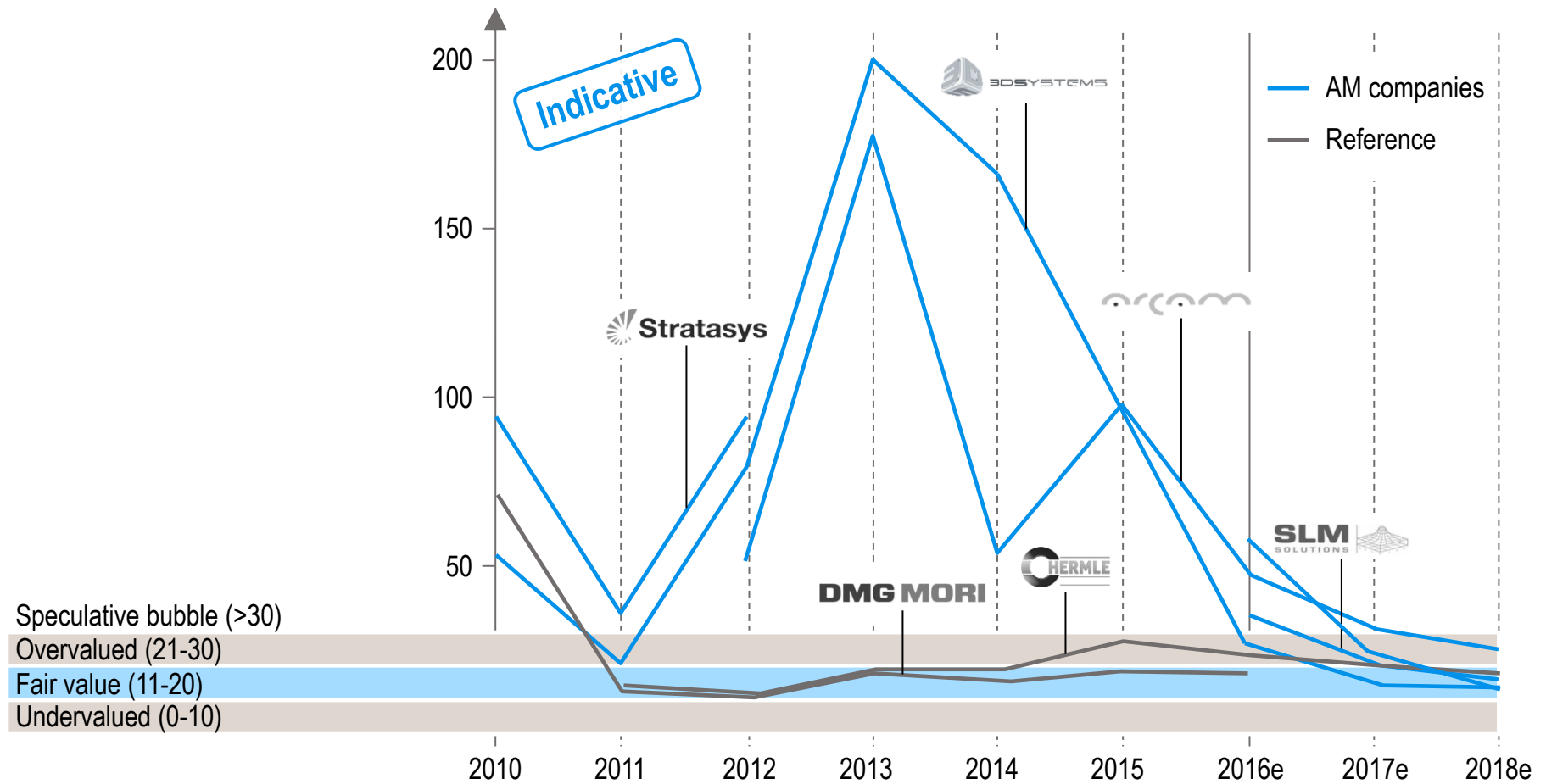

Disclaimer

The study at hand was created by Roland Berger.

Roland Berger, founded in 1967, is the only leading global consultancy of German heritage and European origin. With 2,400 employees working in 36 countries, we have successful operations in all major international markets. Our 50 offices are located in the key global business hubs. Roland Berger advises major international industry and service companies as well as public institutions. Our services cover the entire range of management consulting from strategic advice to successful implementation.

The study at hand was particularly created for the benefit of the recipient and is based on certain assumptions and information available at the publishing date. Roland Berger does not give an express or implied warranty regarding the correctness and completeness of the information contained in this study. There is no guarantee that the included projections or estimates will be realized. No indication or statement in this study shall be understood as an assured prediction. Information provided by collaborating companies and research institutes has not been verified by Roland Berger. The reader should not act on any information provided in this study without receiving specific professional advice.

In publishing this study, Roland Berger reserves the right to make any necessary amendment or substitution and is not obliged to give the recipient access to the additional information.

Any other use or disclosure of this study to a third party is strictly prohibited, unless expressly permitted via written consent from Roland Berger. The image rights remain with the respective originator at any time.

Roland Berger shall not be liable for any damages resulting from the use of information contained in the study.

© Roland Berger GmbH. All rights reserved.

Roland
Berger

